

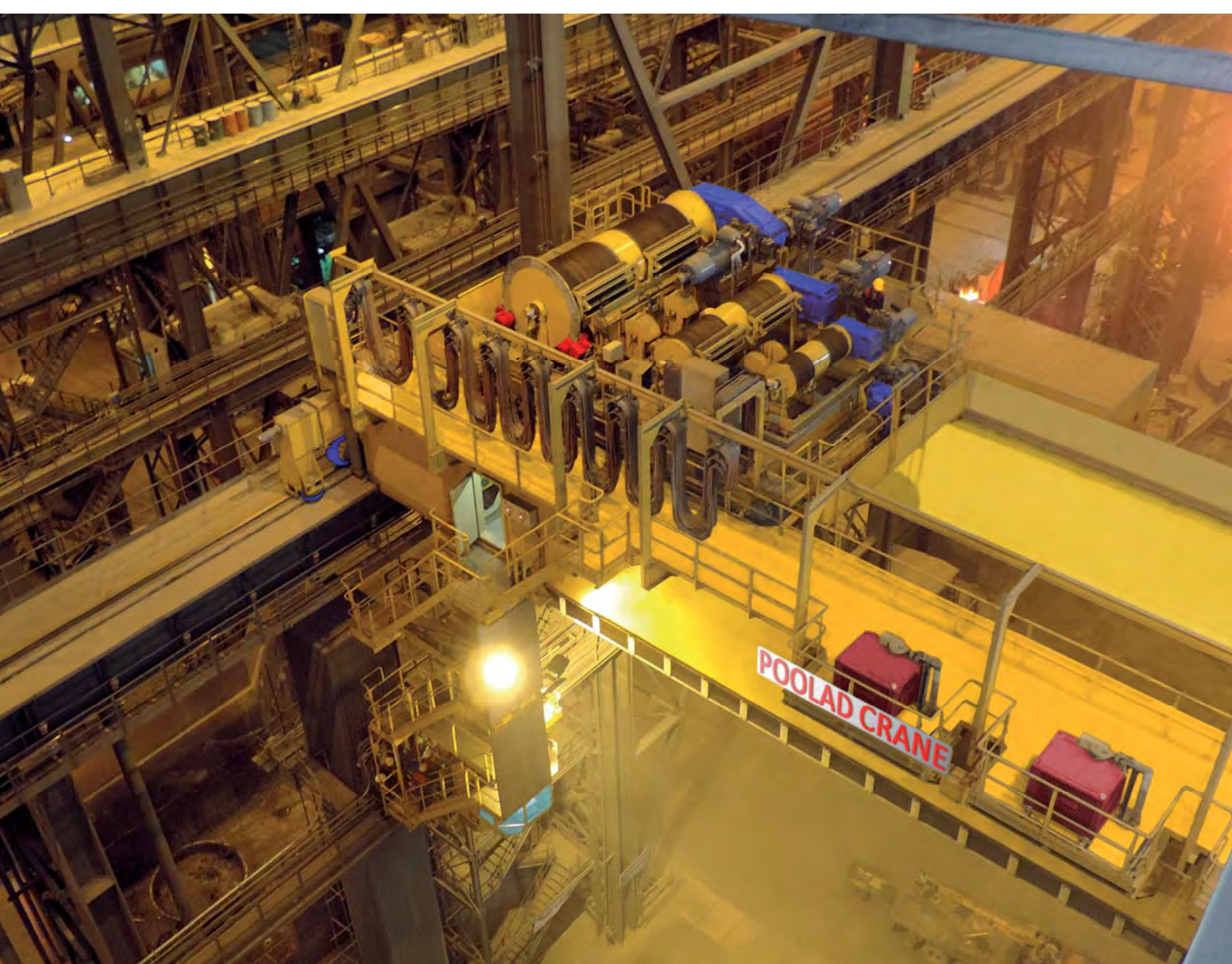

POOLAD CRANE
Materials Handling Equipment

Cranes and Components Materials Handling Equipment



INTRODUCTION



Poolad Crane is one the leading companies in field of cranes systems and materials handling equipment in Iran. We have more than 30 years' experience. The cranes and components are manufactured in Poolad Crane with highest quality and the latest state of the art technology. Our range of products varies from standard cranes to the extreme heavy duty cranes for steel mills and special purpose. Our products will meet any requirement regarding the place of usage and application.



Furnace Bay – Charging Cranes



Scrap Charging Crane 110/40/10 Ton x 30 meters



Slab Tong Cranes



25+25(50)/10 Ton x 28m - Slab Tong Crane



Furnace Bay – Charging Cranes



High Quality Products
Using first class components

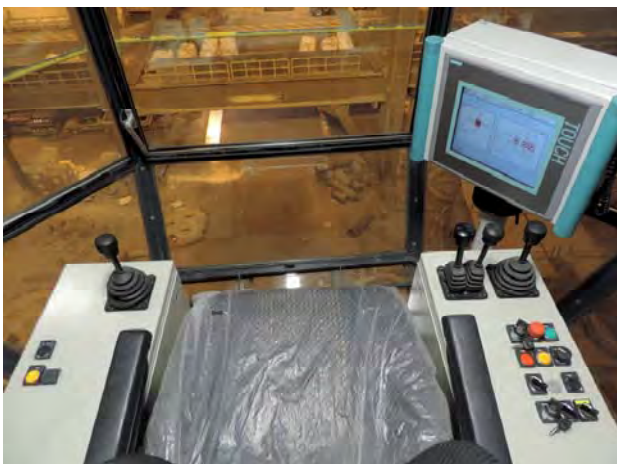

Our cranes are equipped with high-Tech electrical system and control units which will be in accordance of the high precious needs of steel mill industries.

Clients can use the advantages of having back the energy to their system easily.



Know-How and Experience have made our products
Reliable and Durable

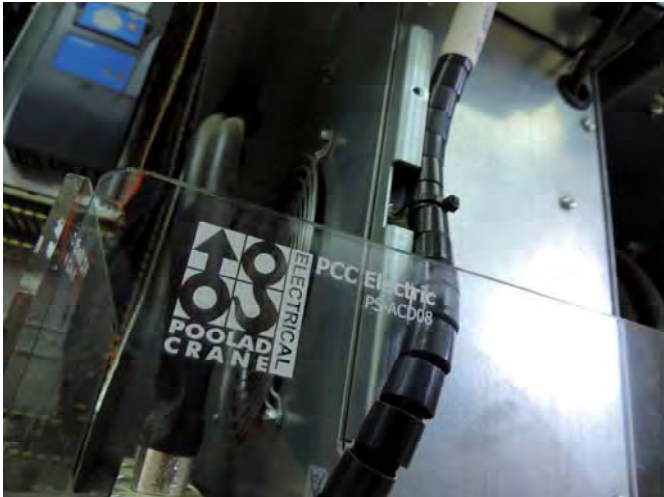

Installation of Heavy Cranes



Installation and delivery of crane at site without shutting down the site with highest safety possible



Shipment of Heavy Cranes



A SUCCESS STORY - Shipment Based on the Safety Regulations



Cranes for Special Purpose



65/16/10 Ton Crane and other 8 Sets cranes for export to Iraq



Process Cranes

Steel Making Plant
Oxygen Plant
EOT Crane
45 Ton



Steel Mill Plant
Gantry Crane
Grab Hook Duty

Steel Making Plant
Ladle Maintenance Workshop
Multi-Purpose Gantry Crane

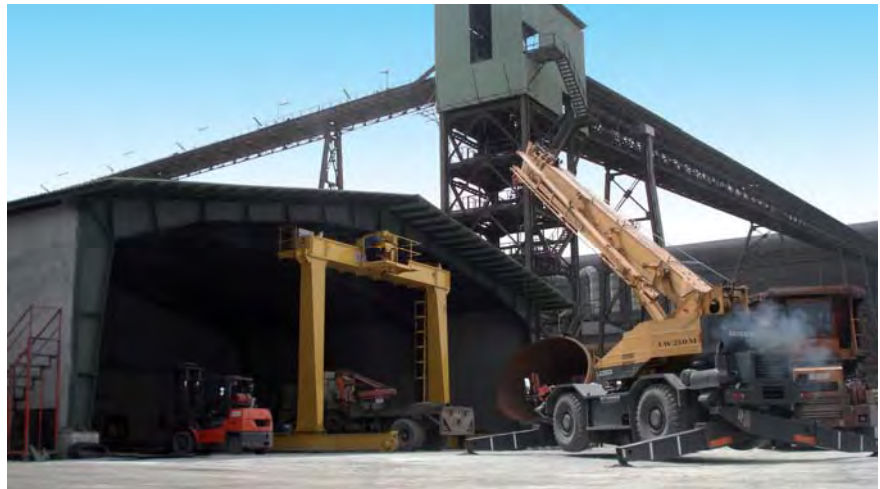

Steel Mill Crane – Billet Bay



Steel Making Plant – Billet Bay Crane – FEM Classification A8 M8



Roll Shop – Cranes 35/15 Ton

Software for Design & Simulation

Together with our experience, we also use the latest software for design and analyze of our products

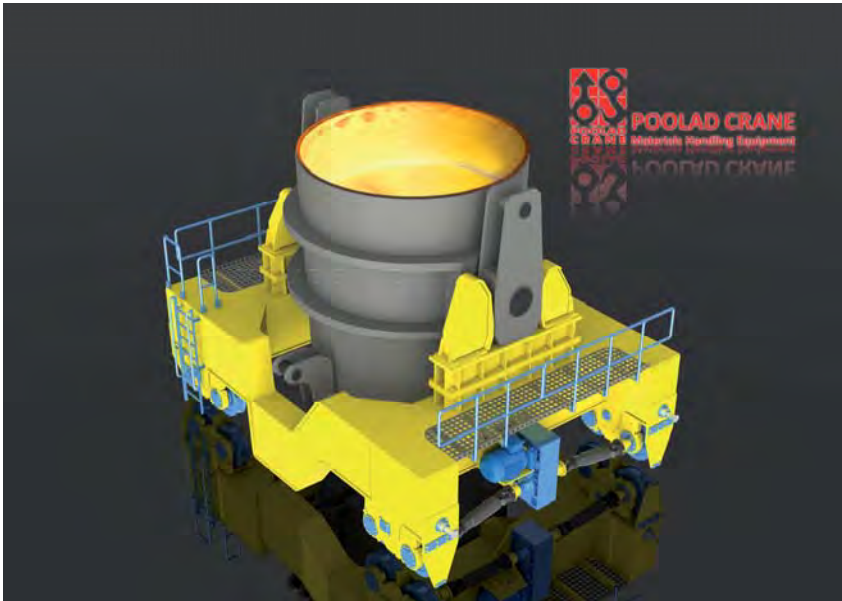
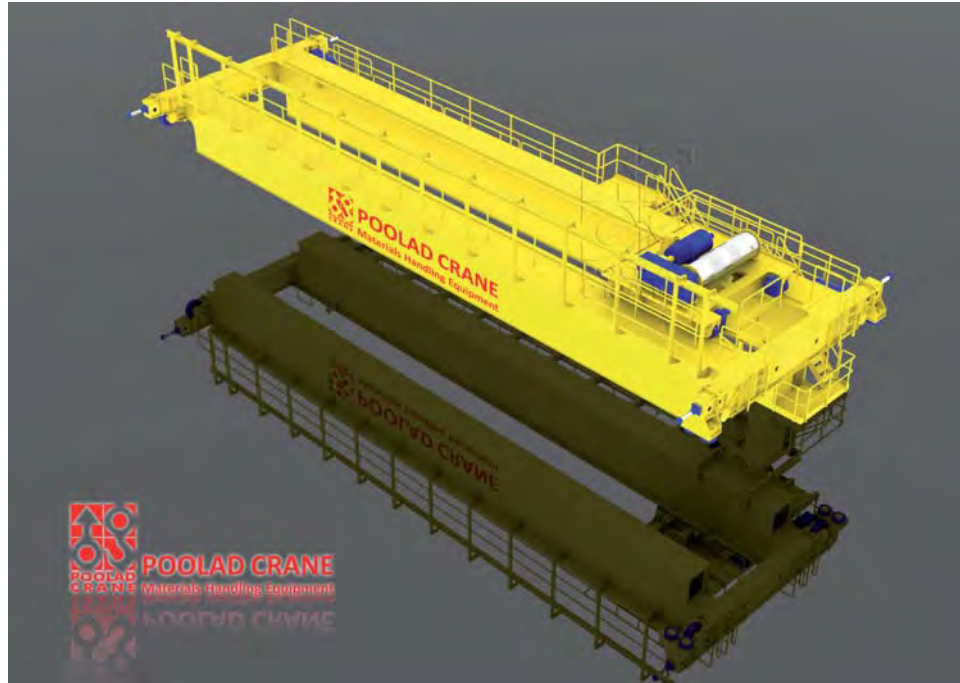

Steel Mill Plant
Transfer Cars
Capacity: 270-Ton

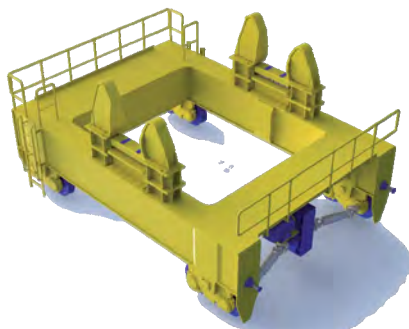

First Class Engineering Services

We present to our special steel mill clients our first class engineering services, one of the biggest issue in this field was the upgrading, refurbishment and capacity increasing of 3-sets of charging cranes in steel mill from 275-Ton to 300-Ton, the project was done according to the needs and technical requirements of the client.



Upgrading and presenting the solution to solve the problems of scrap charging cranes 100/25-Ton in steel mill.



Press Shops Cranes – Transfer Cars

IHDM
17 Sets EOT Cranes
from 5 to 40 Ton
Press Shops
Process Cranes



Saipa Press
11 Sets EOT Cranes from
12.5 to 40/10 Ton
Press Shops
Process Cranes

75-Ton Bogie
Transfer Car
Dies Handling
Press Shops



Heavy Duty Cranes

Siah Bishe Dam
EOT Cranes 25/5 Ton
2 Sets

Extreme heavy duty cranes installed on the hard condition of underground with so many explosion on this environment the cranes did the perfect job to help the client continue working. The cranes were designed to work on two different spans.



Gotvand Dam
Kian Payab
EOT Cranes
2x20(40)Ton
2 Sets



Coating of offshore Pipes
EOT Cranes
2x16 Ton

Dam Spillway Gantry Cranes



Dam Crane –Gantry Crane 40/3.2 Ton – with 8 meters outreach access for gate maintenance

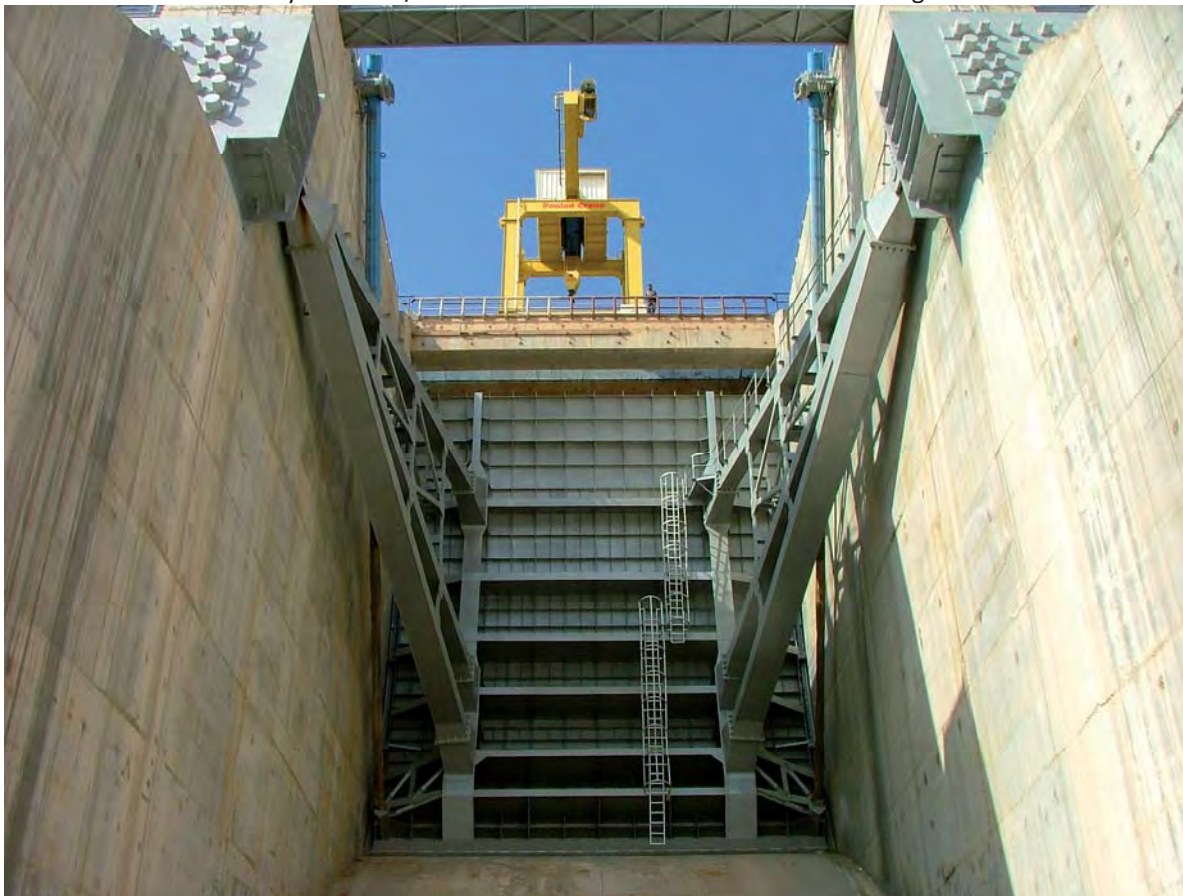

Gantry Cranes for Precious Lifting



Dam– Gantry Crane 40/5 Ton with 50 meters lifting height for installation of the pipes of dam.

250-Ton Locomotive Transfer Table



IRI - Railway Company
Locomotive Transfer Table
250-Ton

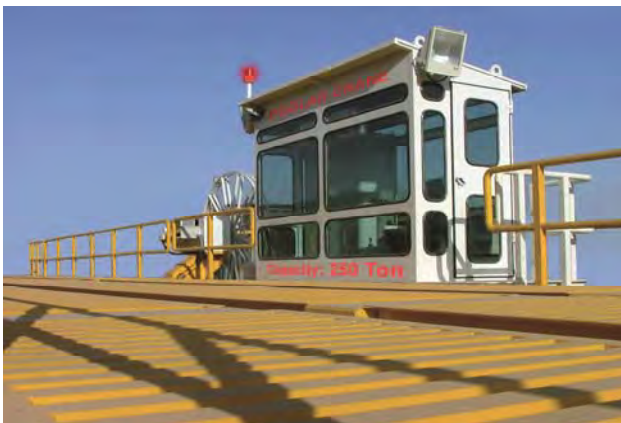

Multi-Purpose Gantry Cranes



Poolad Crane Co. – Gantry Crane 50-Ton – Length of Girder 36 meters

Complete Manufacturing Facilities



Gantry Cranes
at Poolad Crane's
factory
50 Ton x 36 meters
20 Ton x 36 meters

Heavy Lathe Machine
Machining line
For manufacturing of heavy duty cranes drums



Complete range of machines and equipment for manufacturing of heavy duty cranes

References

- Some of our recent and present projects are as follow:

No.	Crane / Equipment	QTY	Capacity	Fem Class.	Span /Length	Customer	Project /Supply
1	Furnace Charging Crane	1	110/40/10 Ton	A7 M7	30 m	Mobarakeh Steel Co.	
2	Slab Tong Crane	1	25+25(50)/10 Ton	A8 M8	28 m	Mobarakeh Steel Co.	
3	Charging Crane	1	320 Ton	A8 M8	30 m	Mobarakeh Steel Co.	Trolley equipment
4	Ladle Crane	3	275/40 Ton	A8 M8	22 m	Khouzestan Steel Co.	Eng. Capacity Increasing
5	Furnace Charging Crane	3	100/40 Ton	A8 M8	26 m	Khouzestan Steel Co.	Inspection and Solutions
6	EAF Ladle Car	1	270 Ton	A8 M8	120 m	Chadormalu mining & Industrial Co	Engineering
7	LF Ladle Car	1	270 Ton	A8 M8	100 m	Chadormalu mining & Industrial Co	Engineering
8	Ladle Inter Bay Car	1	270 Ton	A8 M8	80 m	Chadormalu mining & Industrial Co	Engineering
9	Scrap Bucket Car	1	170 Ton	A8 M8	60 m	Chadormalu mining & Industrial Co	Engineering
10	Tundish Crane	1	120/40 Ton	A6 M6	28 m	Mobarakeh Steel Co.	
11	Slab Tong Crane	1	60/10 Ton	A8 M8	35.5 m	Mobarakeh Steel Co.	
12	Slab Tong Crane	1	50/10 Ton	A8 M8	35.5 m	Mobarakeh Steel Co.	
13	Slab Tong Crane	1	50/12 Ton	A7 M7	20 m	Mobarakeh Steel Co.	
14	Billet Car	1	17.7 Ton	A8 M8	120 m	Chadormalu mining & Industrial Co	Engineering
15	Billet Bay Crane	1	20 Ton	A8 M8	28 m	Khouzestan Steel Co.	Replacement
16	EOT Cranes	2	25 Ton	A8 M8	30 m	Mobarakeh Steel Co.	Hoist components
17	EOT Cranes	3	35-15 Ton	A6 M6	20 m	Khouzestan Oxin Steel	
18	Oxygen Plant Crane	2	45-25 Ton	A6 M6	24 m	Mobarakeh Steel Co.	
19	Locomotive Transfer Table	2	250 Ton	A7 M7	32 m	Islamic Republic Of Iran Railways	
20	Scrap Yard Crane	2	20 Ton	A8 M8	20 m	Chadormalu mining & Industrial Co	
21	Maintenance Hoists	3	20 Ton	A7 M7	40 m	Khouzestan Steel Co.	
22	Process Crane Crusher line	4	75-15-10 Ton	A6 M6	20 m	Cement Payvand Golestan	
23	Turbine Hall Crane	1	65/16/10 Ton	A6 M6	16 m	Sunir –Ameran Ofogh	

24	Process Crane Crusher line	3	50-10-5 Ton	A6 M6	20 m	Cement Faraz Firouzkouh	
25	Process Crane Press Shop	17	40-32-16 Ton	A6 M6	32 m	IHDM	
26	Process Crane Press Shop	11	40-25-12.5 Ton	A6 M6	24 m	Saipa Press	
27	Gantry Crane	1	42.5/5 Ton	A7 M7	18 m	Kian Payab	
28	Transfer Car Press Shop	1	75 Ton	A7 M7	250 m	Saipa Press	
29	Transfer Car Press Shop	3	45 Ton	A6 M6	60 m	IHDM	
30	EOT Crane	2	25/6 Ton	A7 M7	30 m	Farab	
31	Gantry Crane	1	40/3.2 Ton	A6 M6	30 m	Sadid Jahan Sanat	
32	Special Purpose EOT Crane	1	32/6 Ton	A7 M7	30 m	Islamic Republic Of Iran Railways	
33	Process Crane	2	32 Ton	A7 M7	18 m	SADAF	
34	Ferroalloy Crane/ W.Crane	3	10 Ton	A7 M7	18 m	Chadormalu mining & Industrial Co	
35	Gantry Crane	1	20Ton	A7 M7	30 m	Sadad Machine	
36	Empty Ladle Crane	1	75 Ton	A7 M7	26 m	Hormozgan Steel	Hoist Brake
37	Cable Reel	6	270 Ton	A7 M7	120 m	Mobarakeh Steel Co.	Transfercar
38	Cable Reel	6	150 Ton	A7 M7	100 m	Khorasan Steel Co.	Transfercar
39	Grab Gantry Crane	1	3 Ton	A7 M7	6+8 m	Mobarakeh Steel Co.	
40	Monorails & Hoists	28	3-15 Ton	M6	--	Mobarakeh Steel Co.	
41	Charging Monorails	4	5 Ton	M7	--	Mobarakeh Steel Co.	
42	Turn Table	8	250 Ton	A7 M7	30 m	Islamic Republic Of Iran Railways	Present
43	Gantry Crane	1	110 Ton	A5 M5	15 m	Kian Payab	
44	Ladle Crane	1	90/35 Ton	A7 M7	28 m	Hormozgan Steel	Present
45	Oil Buffer	64	70-275 Ton	A8 M8	26 m	Khuzestan Steel Co.	
46	Cranes & Hoists	23	5-20 Ton	A5 M5	20 m	Saba Steel Co.	Present
47	Cranes & Hoists	6	5-25 Ton	A6 M6	25 m	Kian Payab	
48	Gantry Crane	1	35 Ton	A8 M8	32 m	Mobarakeh Steel Co.	Present
49	EOT Crane	2	50/16 Ton	A6 M6	30 m	Mobarakeh Steel Co.	Hooks
50	Ladle Crane	4	240 Ton	A8 M8	26 m	Hormozgan Steel	Hooks

Valuable Customers



- Some of our valuable customers:



Mobarakeh steel Co.



Khouzestan Steel Co.



Railway of IR IRAN



NISCO – Chahar Mahal



IHDM



Khouzestan Oxin Steel Co.



Hormozgan Steel Co.



Chadormalu Steel Co.



Pamidco



Saipa Press



MME Co.



MMTE Co.



Saba Steel



Sadid Pipe & Profile



Moshanir



Sunir



Ameran Ofogh



Espandar Cement Co.



Tableh



Farab



Sadaf



General Mechanic



Sadid Co.



Kian Payab



KWPA Org.



Sharif University



Pargasiran Co.



Golestan Cement Co.



Arj Co.



Butane Co.



PETCo



Fazasazan Amin Co.



Pars Moshabak



Niro Moharekeh



RSTC Co.



Wood Group



Iran Model Co.



Shibeh Co.



PS Co.



Indamin Co.



POOLAD
CRANE

Address:

No.86, Hossainabad Ave., 8th km of Tehran-Saveh Rd., Tehran - Iran

Postal Code: 3319963435

Website: www.pooladcrane.com/Home

E-Mail: info@pooladcrane.com

E-Catalog: www.pooladcrane.com

Tel.: +98 (0) 21 5524 2879 (6 lines)

Fax: +98 (0) 21 5524 1521