

**STEMMANN-TECHNIK**

*A Wabtec subsidiary*



## Alternative Maritime Power Systems

Daiei Hoffmans, International Sales Manager





# Onshore Power Supply & Charging Systems

Reduction of Emissions in Ports



The emissions caused in the port area are a growing problem due to the increasing capacities of the ports.



The onshore power supply units will replace the diesel-powered vessel generators to a large extent.

The implementation of emission limit values and environmental specifications in general expedite this development.



# Onshore Power Supply & Charging Systems

Various Solutions for...

## Container Vessels

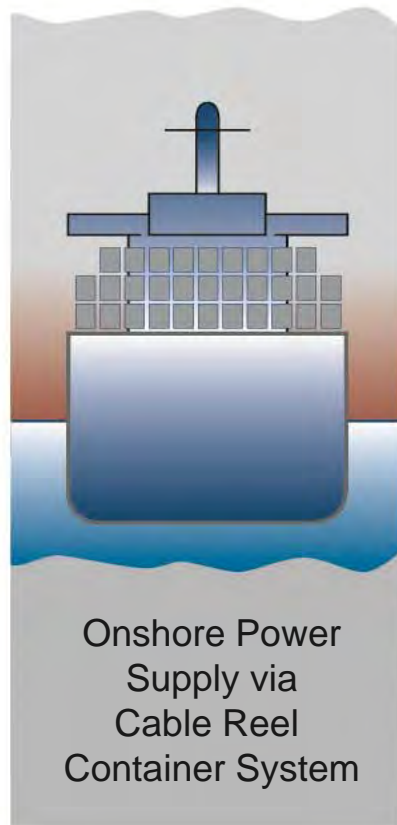

## Cruise Liner

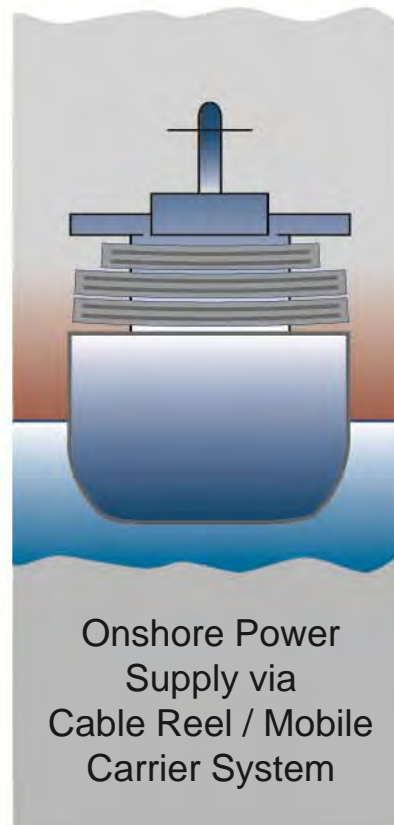

## Electrical Ferries

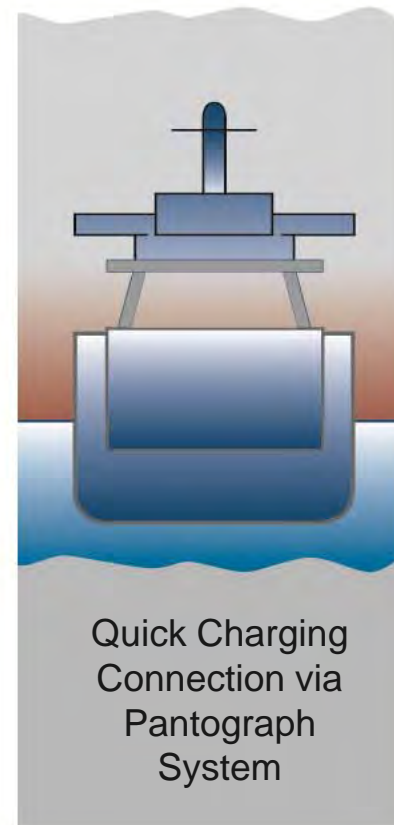

## Yachts

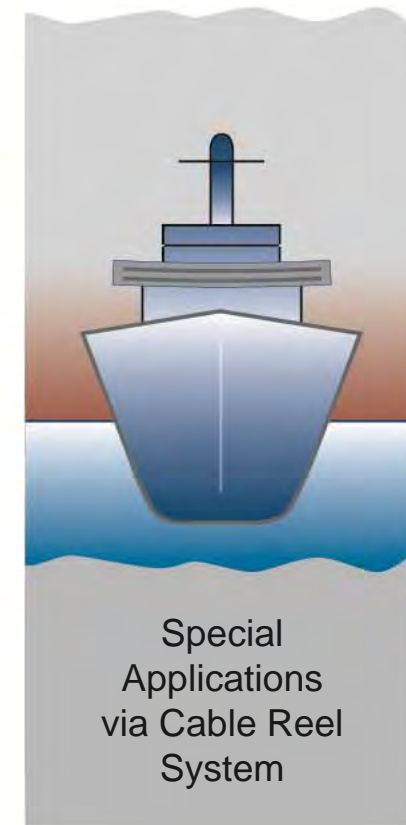



# Onshore Power Supply for Container Vessels

Onshore Power Supply via Cable Reel Container Systems

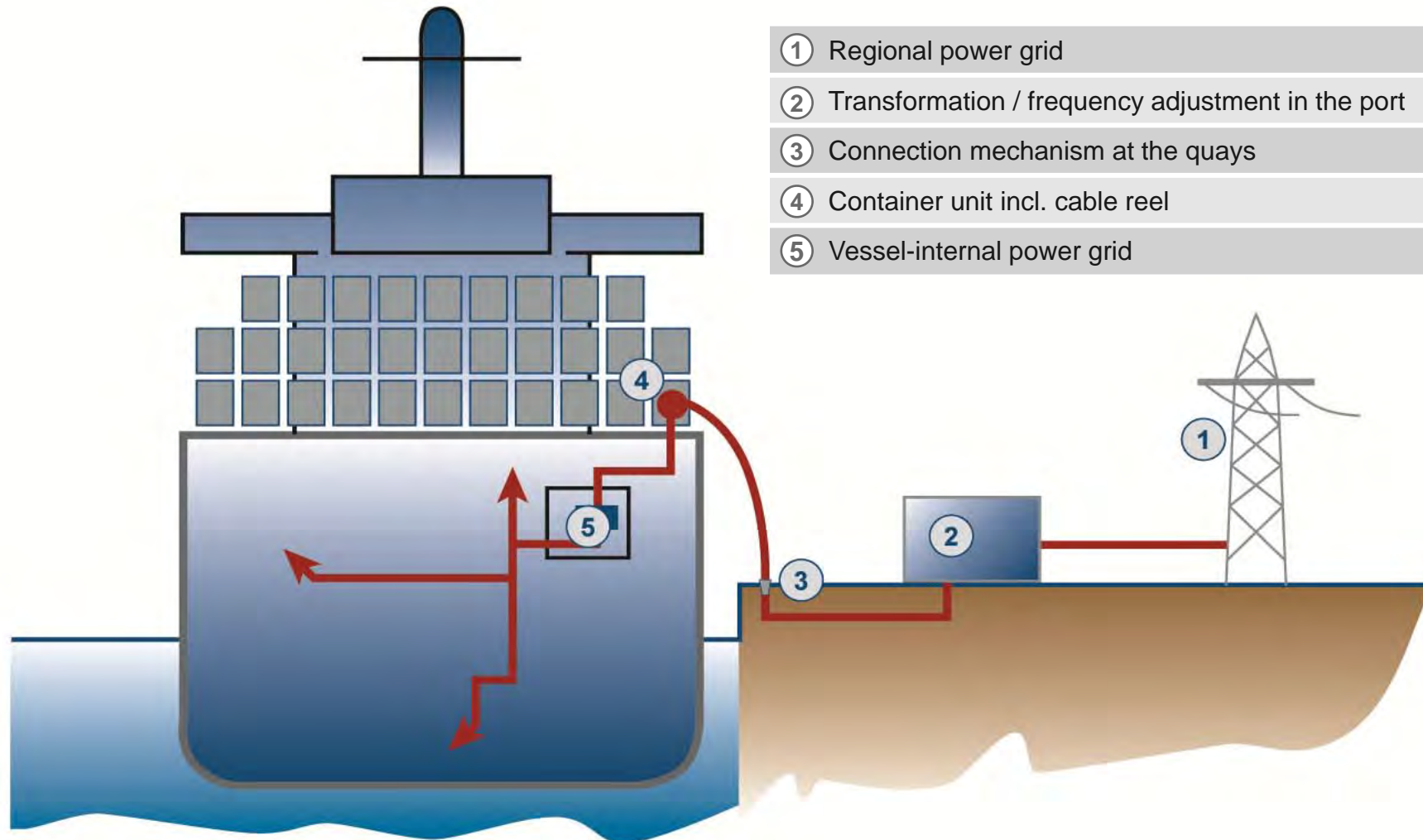





# Onshore Power Supply for Container Vessels

Onshore Power Supply via Cable Reel Container Systems

## Onboard System





# Onshore Power Supply for Container Vessels

Onshore Power Supply via Cable Reel Container Systems



The feed of the onshore power supply for container vessels is realised for example by the installation of a 40 ft. HC-container in the bottom storage row.

The system consists of a spiral cable reel with slip ring assembly and fibre optic rotary connector incl. the drives for the reel and the extension system of the roller conveyer.



# Onshore Power Supply for Container Vessels

Onshore Power Supply via Cable Reel Container Systems

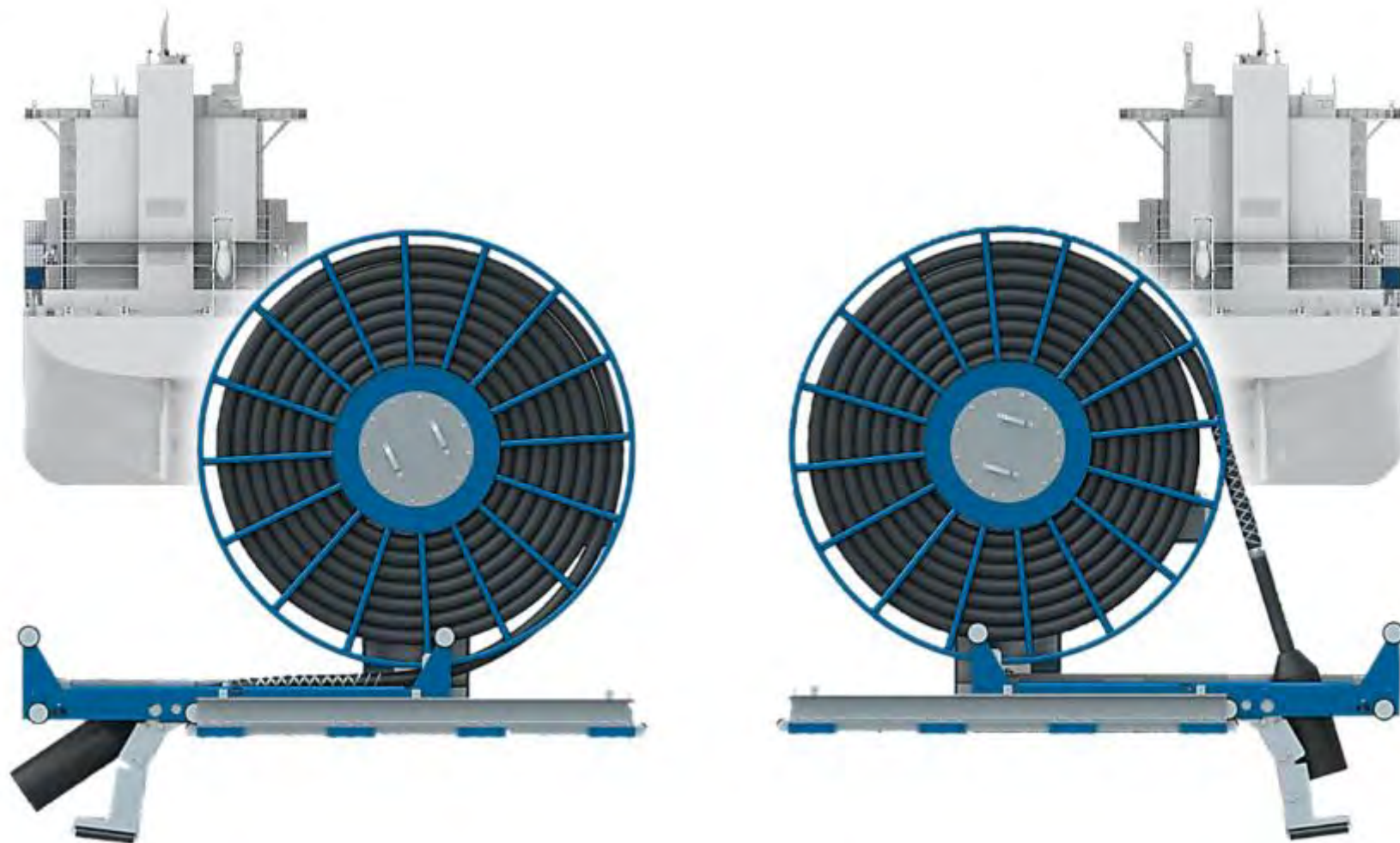





# Onshore Power Supply for Container Vessels

Onshore Power Supply via Cable Reel / Mobile Socket System

## Onshore System



Combination of HC-container installation on board and mobile socket installation onshore.

Flexible mounting heights depending on the local conditions.

Flexible traveling lengths depending on the local conditions.





# Onshore Power Supply for Container Vessels

Onshore Power Supply via Mobile Socket Systems

## Onshore System

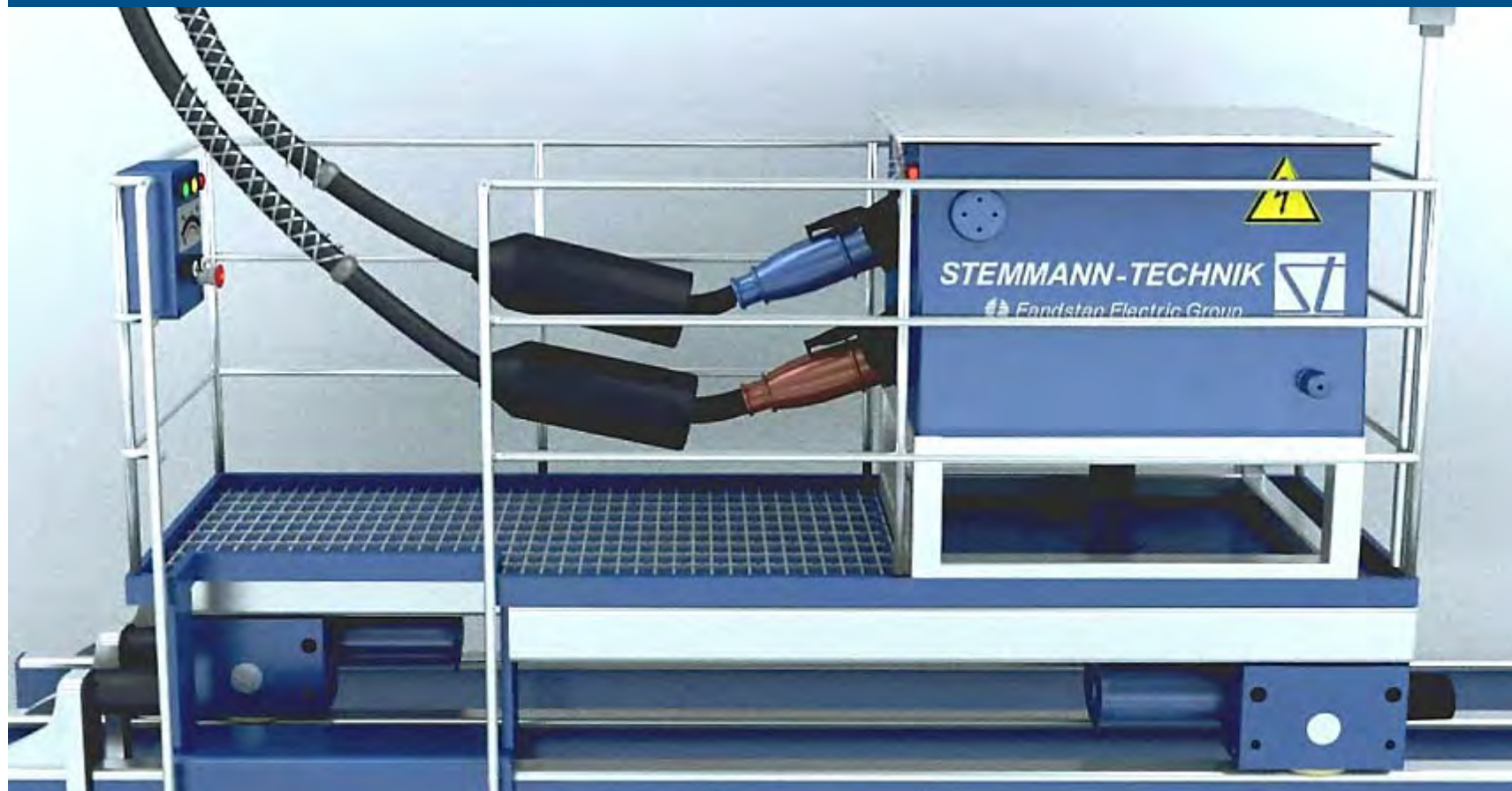



# Onshore Power Supply for Container Vessels

## Container System Advantages



HC-container installation in the bottom storage row requires no special housing installation on board.

Installation/cable pay-off on port- or starboard side possible.

Constant tension on cable by torque motor.

Excess tension-coupling for protection from damage to the mechanical parts.

The operation is effected by means of a radio remote control.

Decades of experience in the construction and manufacturing of cable reels.



# Onshore Power Supply for Cruise Liner

Onshore Power Supply via Mobile Carrier Systems

## Onshore System







# Onshore Power Supply for Cruise Liner

Vehicle in Action







# Onshore Power Supply for Cruise Liner

History of the "SAMP Hamburg Altona Project"

Terminal Situation



Ship's hatch / Control Cabinet





# Onshore Power Supply for Cruise Liner

## The Requirements

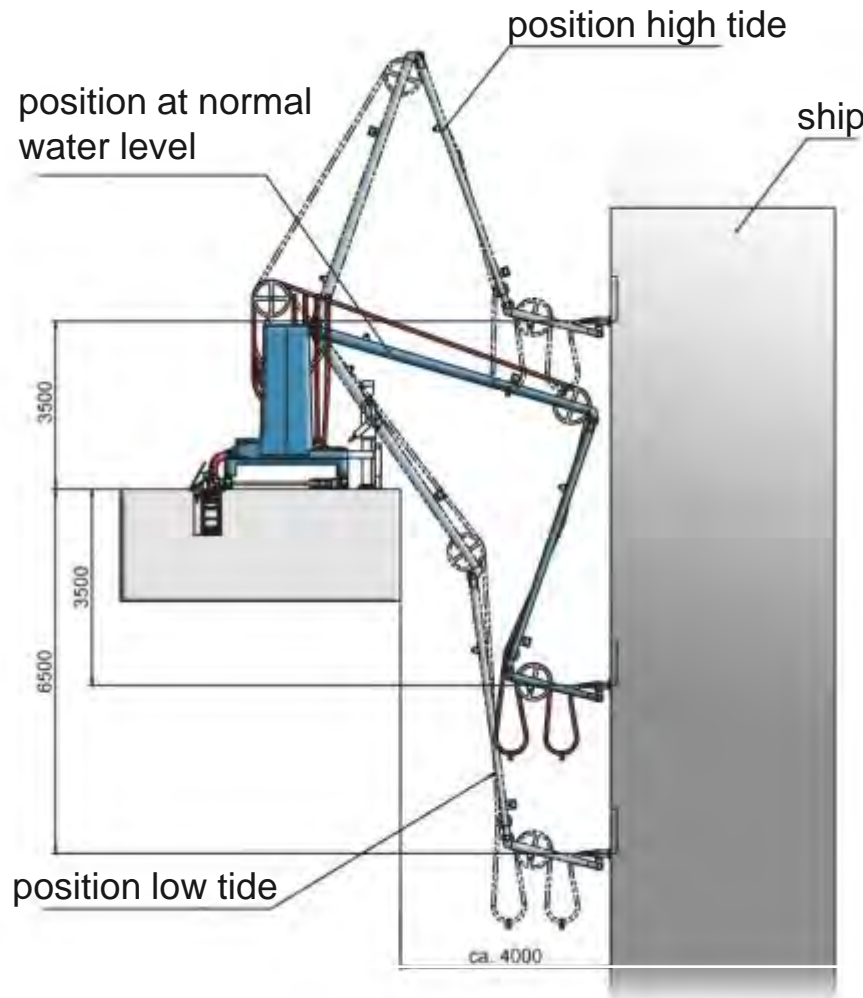

High tide, height difference hatch/quay: **3.5 m**

Low tide, height difference hatch/quay: **6.5 m**

Travel distance parallel to quay wall: **300 m**

Distance between ship and quay wall: **4 m**

Distance between SAMP-System and quay wall: **approx. 2.5 m**

Distance between hatch and socket: **approx. 3.5 m**

Hatch dimensions (h x w): **1.2 x 0.8 m**

Transmittable voltage: **12 MVA**



# Onshore Power Supply for Cruise Liner

Port Side / Cable Duct / Energy Chain







# Onshore Power Supply for Cruise Liner

Transfer Vehicle / Cover Lifting Device with Cable Guideway

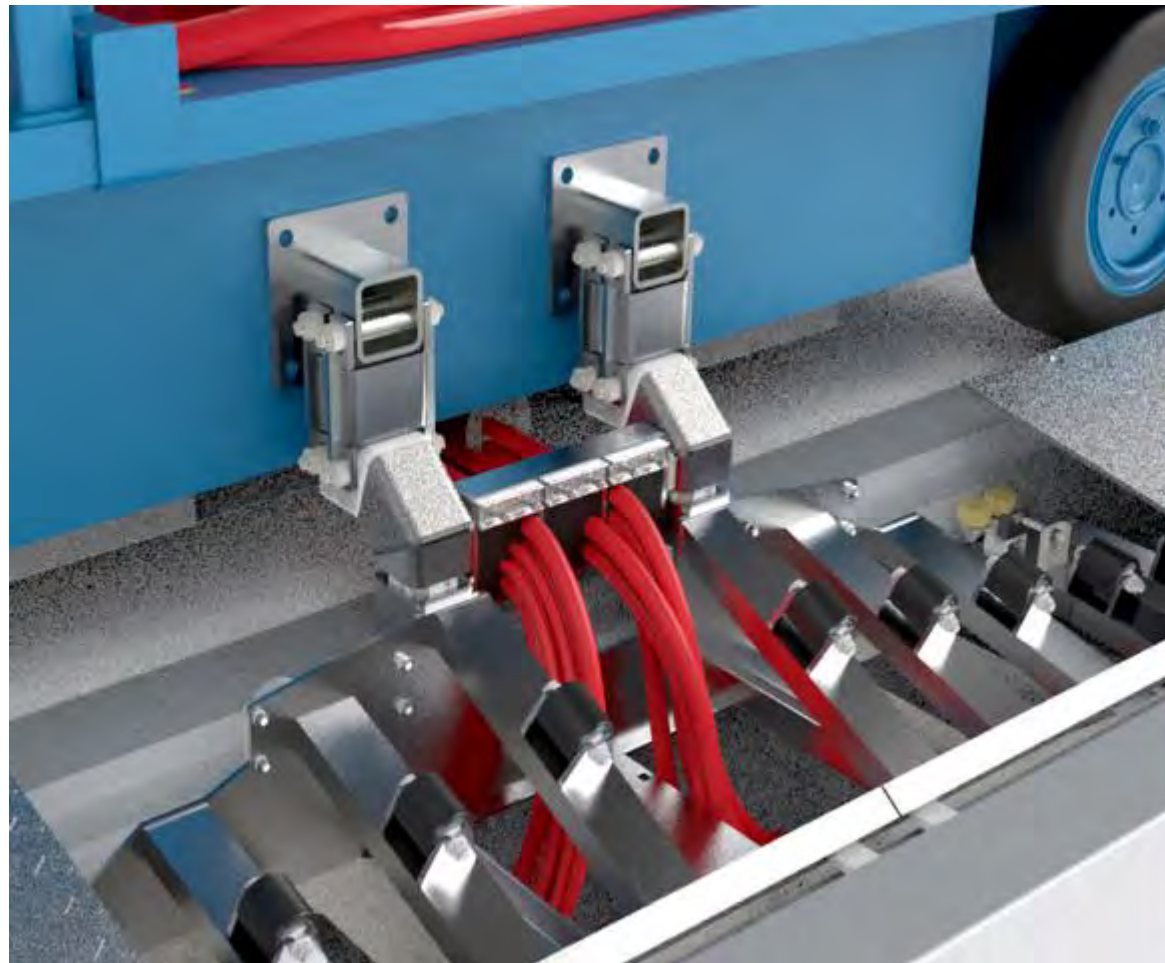





# Onshore Power Supply for Cruise Liner

Telescopic Plug Holder System





# Onshore Power Supply for Cruise Liner

Control Panel

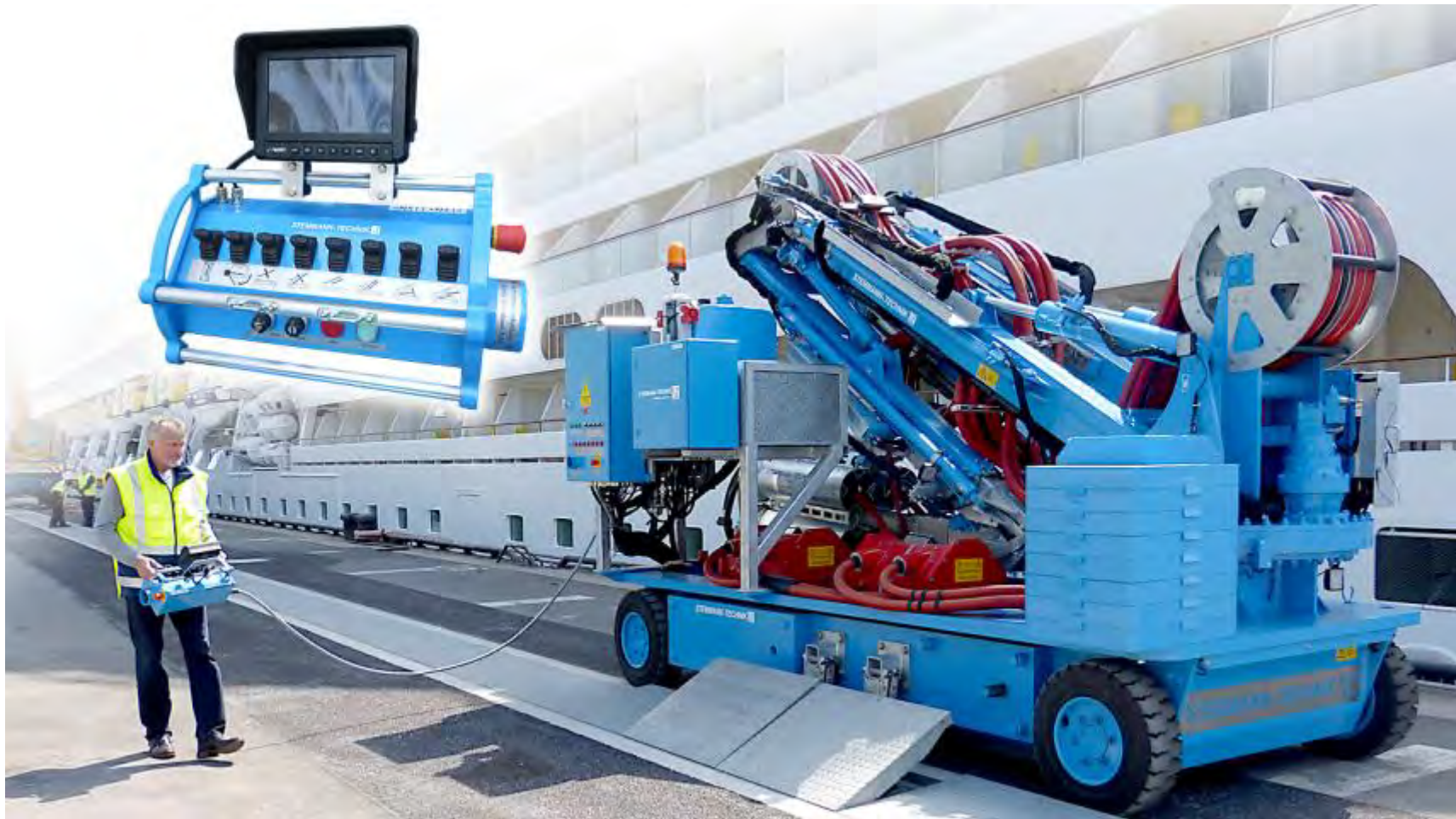





# Onshore Power Supply for Cruise Liner

Story of the "SAMPS Shanghai Project"

Terminal Situation

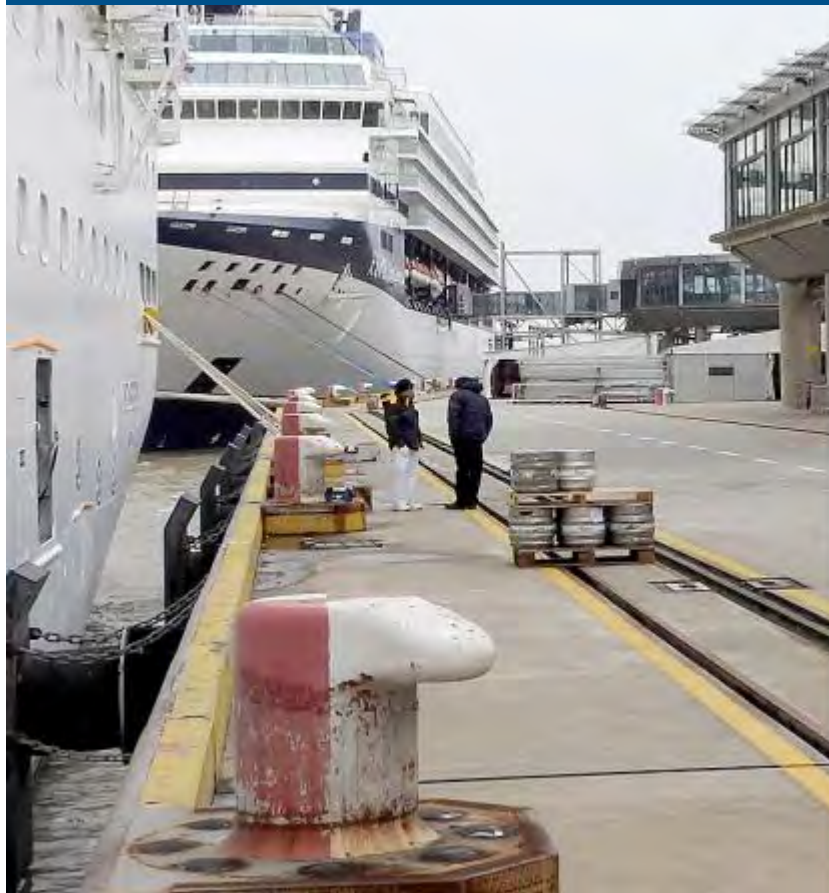

Ship's hatch / Control Cabinet





# Onshore Power Supply for Cruise Liner

Story of the "SAMPS Shanghai Project"

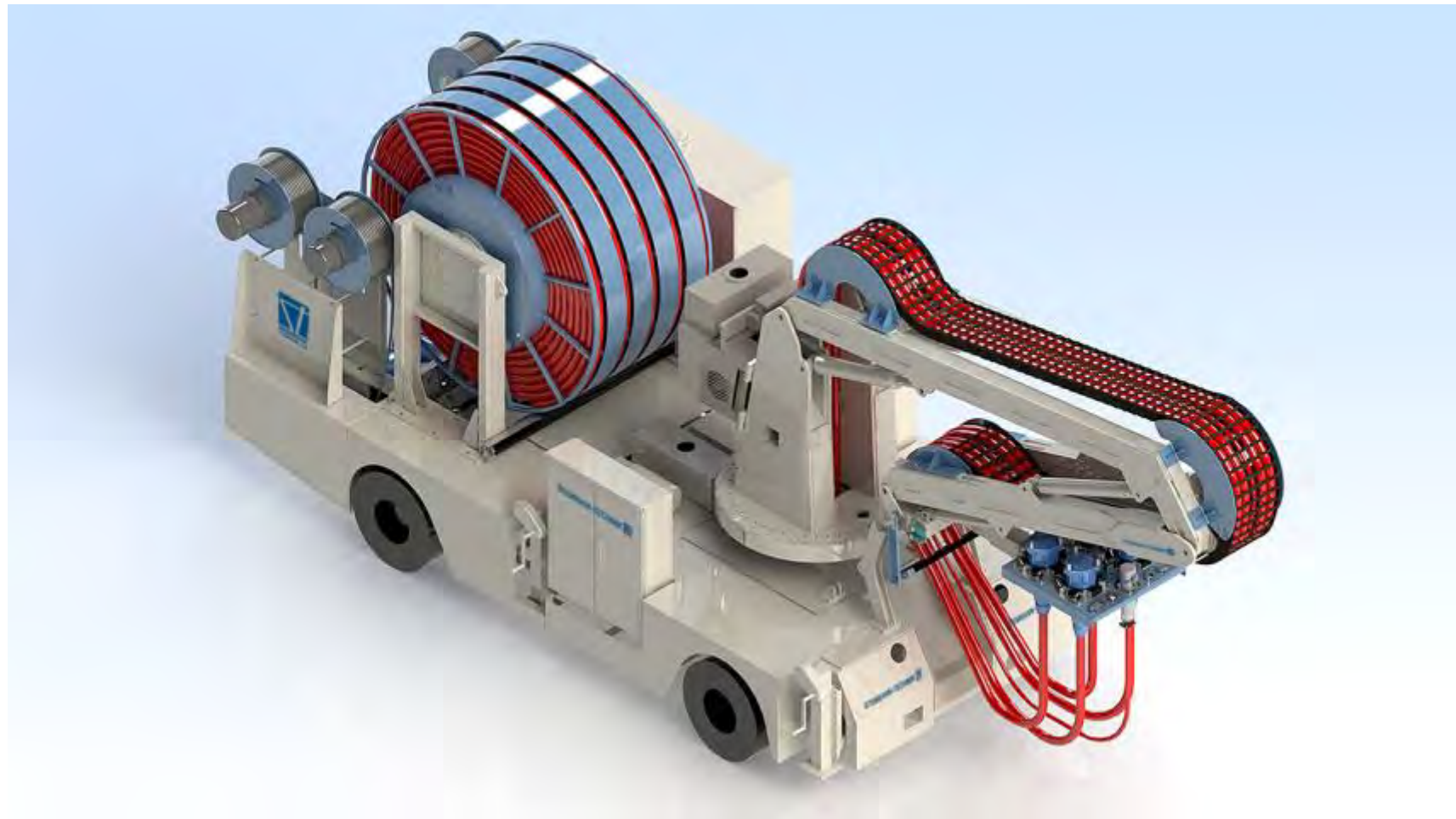





# Onshore Power Supply for Cruise Liner

Story of the "SAMPS Shanghai Project"

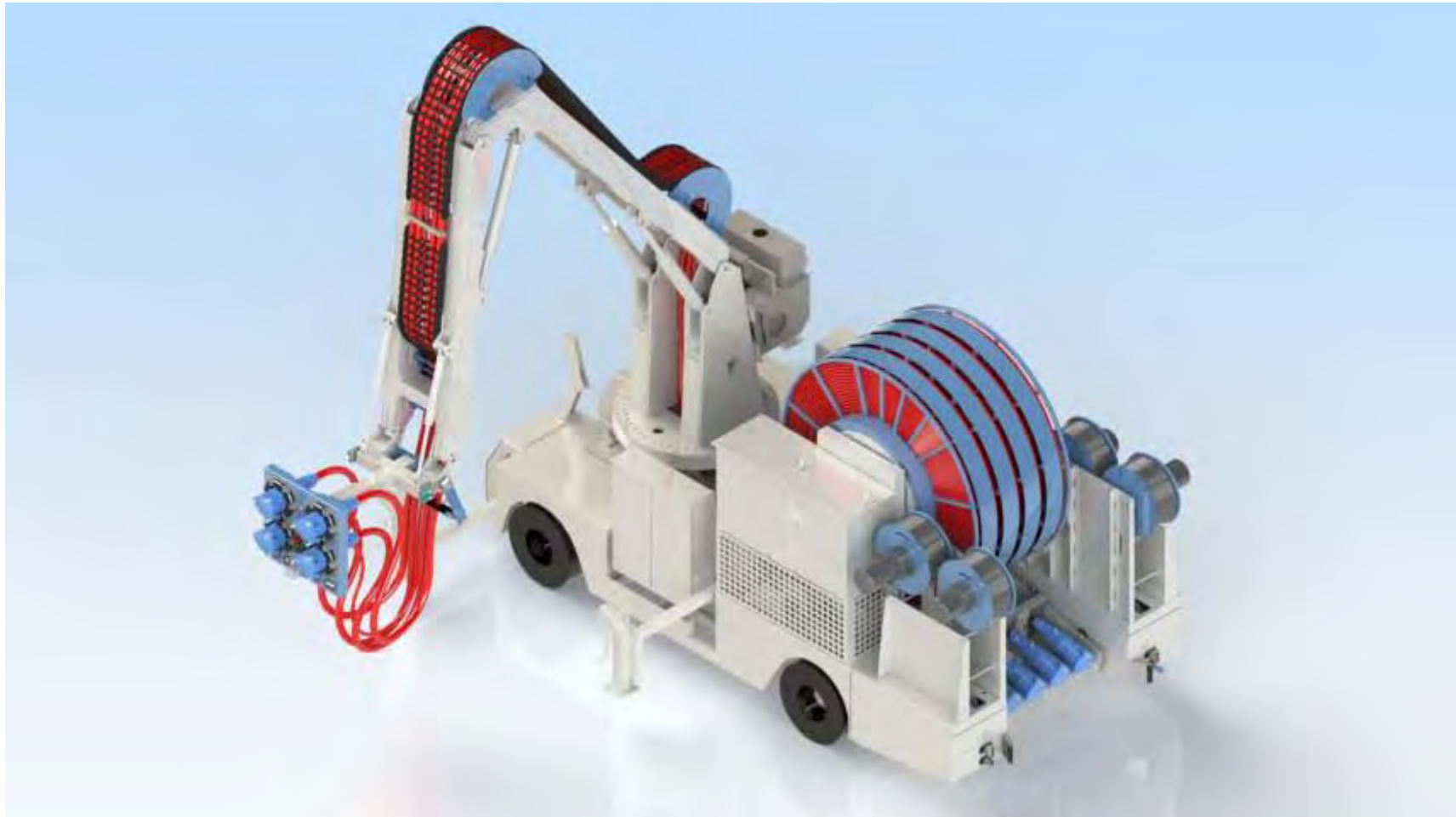



# Onshore Power Supply for Cruise Liner

Story of the "SAMPS Shanghai Project"

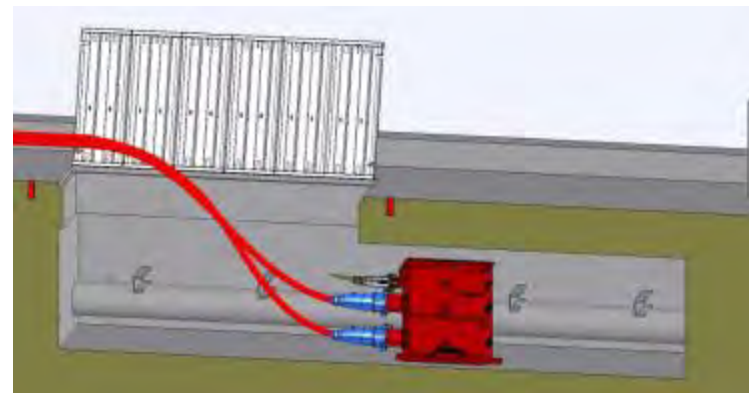
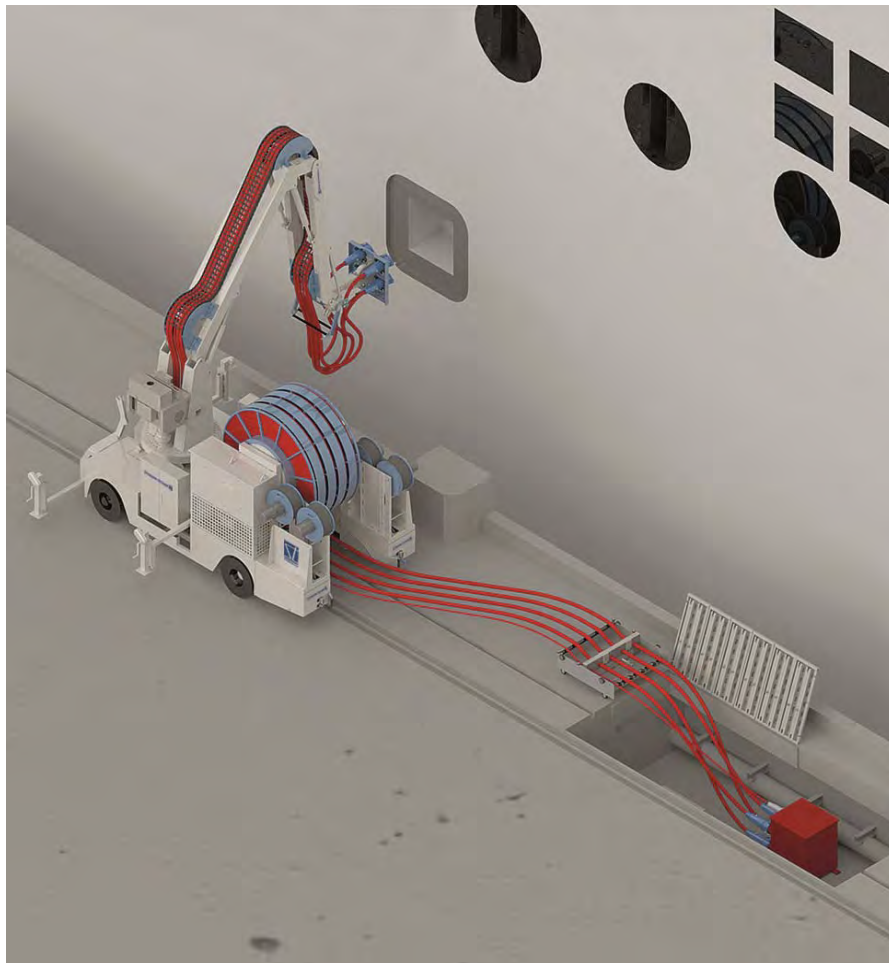



# Electrical Charging System for Ferries

Quick Charging Connection via Pantograph Systems







# Electrical Charging System for Ferries

Quick Charging Connection via Pantograph Systems

## System especially for ferries that cover short distances

120 cars / 360 passengers

Fully recharge in 10 minutes

Passenger service since 2015

400 kW to cruise at 10 knots

Replacement of 2,000-hp diesel engine

Saving 264,000 gallons of fuel/year

Saving nearly 3,000 tons of CO<sub>2</sub>/year

Powered by 800 kW battery





# Electrical Charging System for Ferries

Pantograph System (planning phase)

low tide

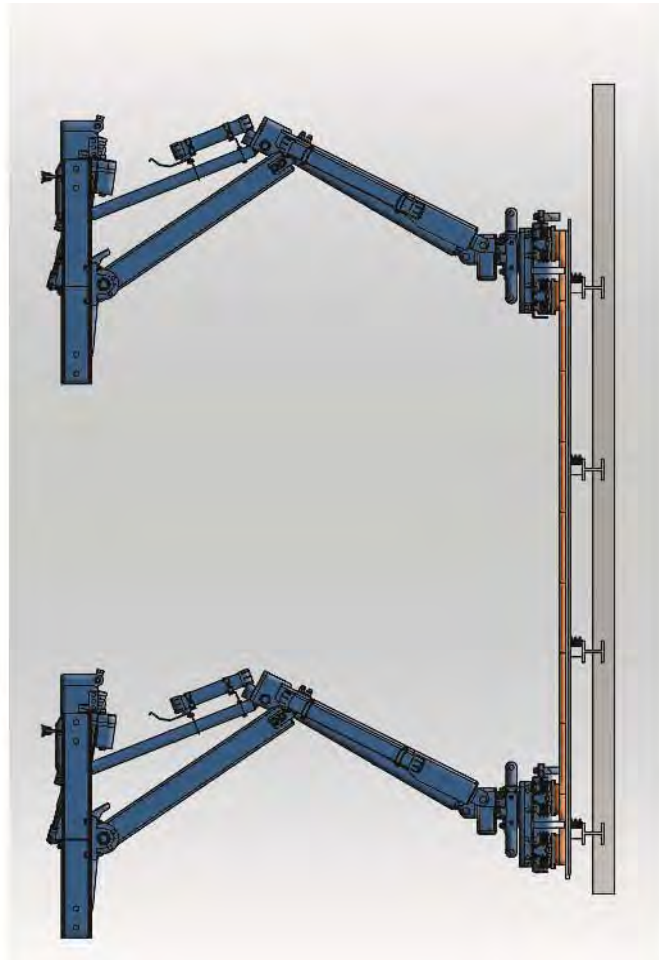

high tide

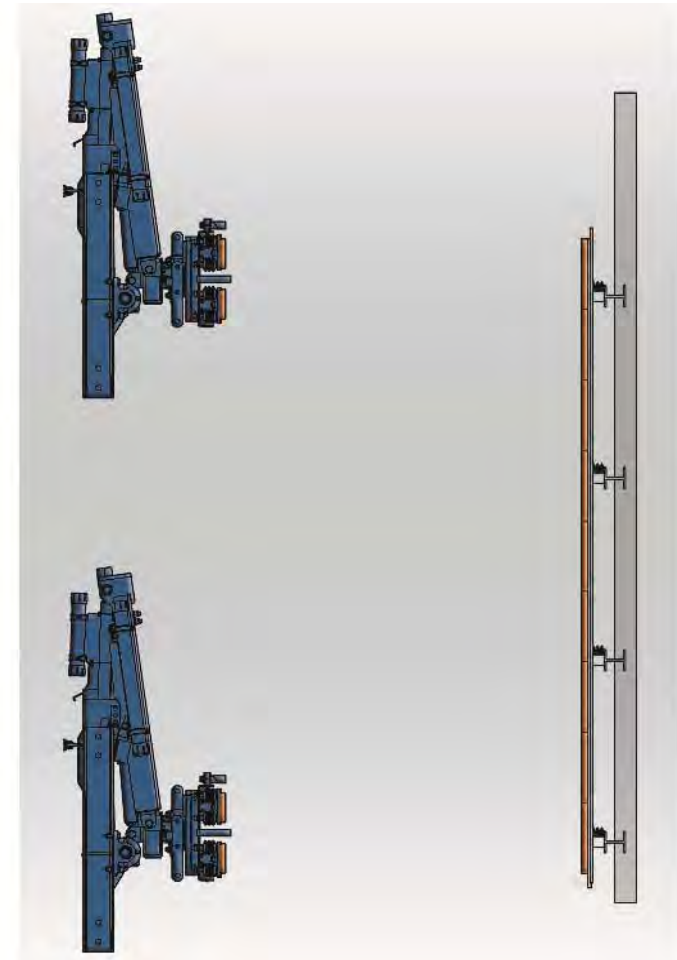



# Electrical Charging System for Ferries

Quick Charging Connection via Pantograph Systems

## System especially for ferries that cover short distances

Fully automated

Connecting/disconnecting  
time only 7 seconds

Compensates the ferry  
movement while docking

System secured into  
attractive housing

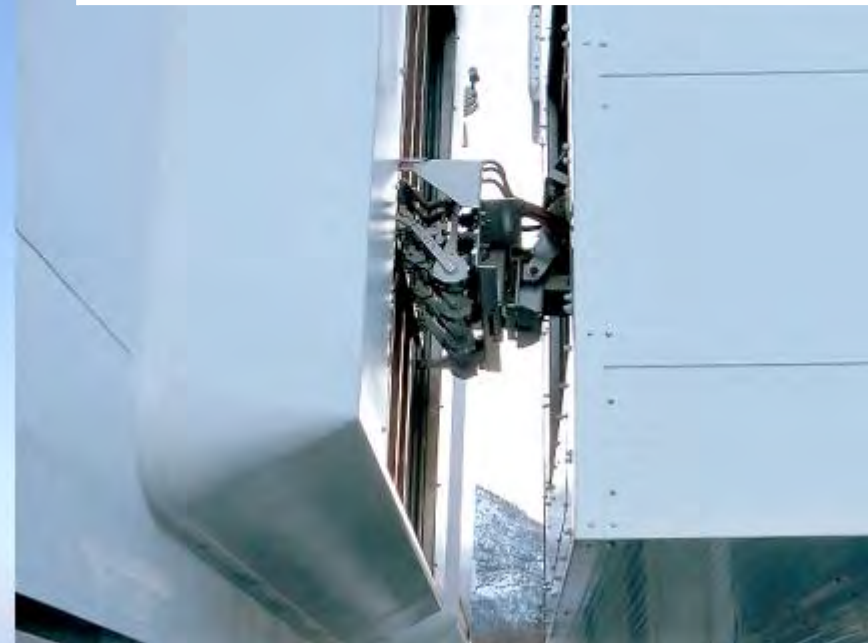





# Electrical Ferry

Pantograph System (planning phase)

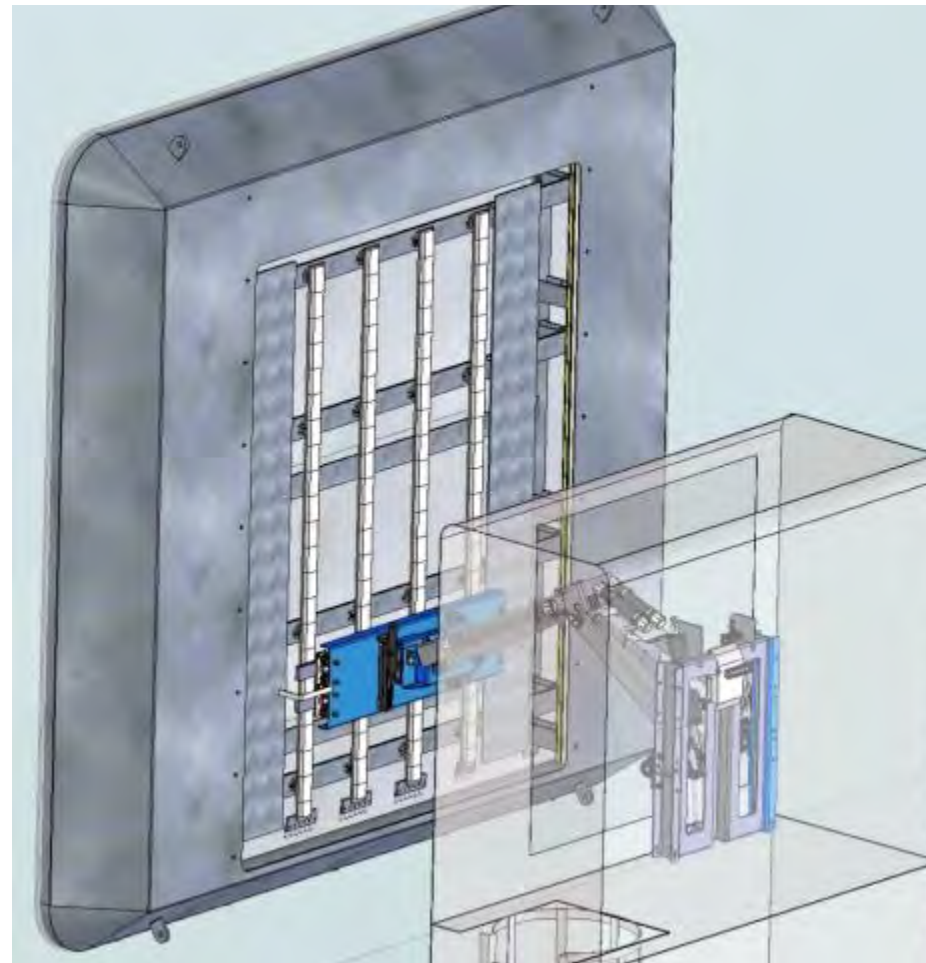
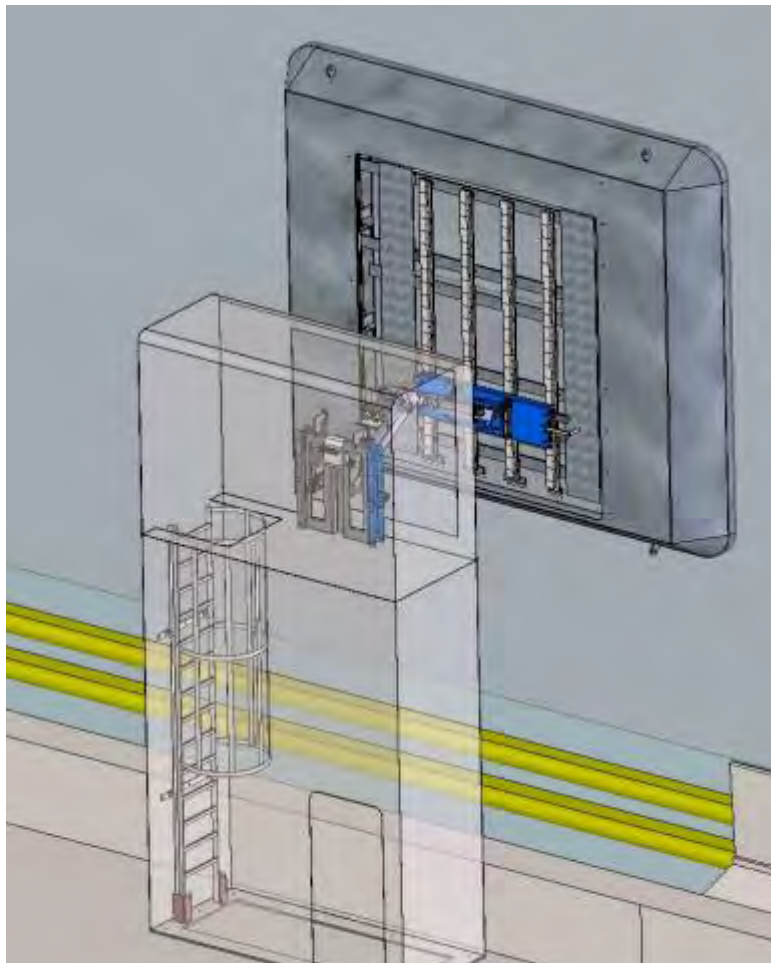



# Electrical Ferry

Pantograph System (real situation)

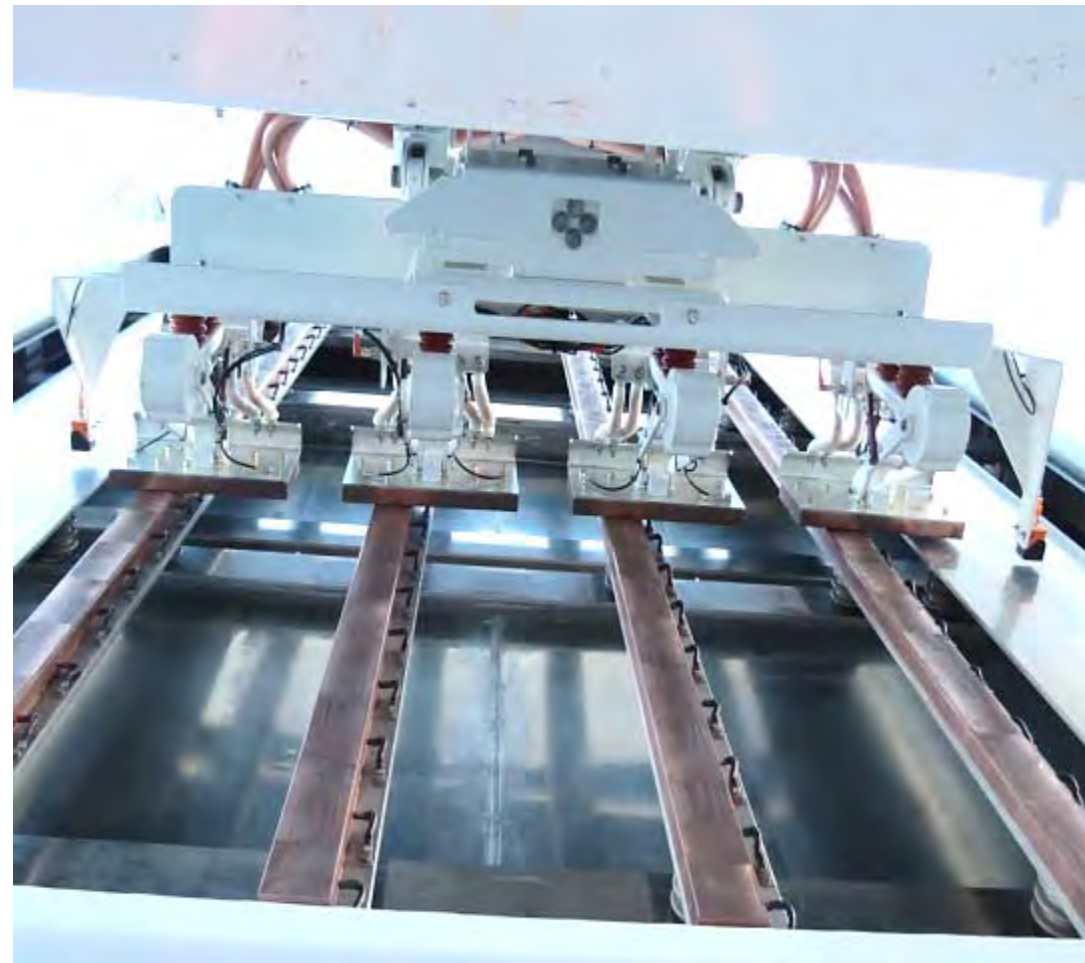



## Onshore Power Supply for RoRo Vessel or Offshore Vessel





**STEMMANN-TECHNIK**

*A Wabtec subsidiary*



**Thank You for Your Attention**

**Stemmman-Technik GmbH**  
Headquarter

Niedersachsenstraße 2  
48465 Schüttorf | Germany

Phone: +49 5923 81 – 0  
Fax: +49 5923 81 – 100

[info@stemmann.de](mailto:info@stemmann.de)  
[www.stemmann.de](http://www.stemmann.de)

