

SAMSON
AUMUNDGROUP



**REDUCING PORT INFRASTRUCTURE COSTS USING
MOBILE BULK HANDLING EQUIPMENT**

LEV EVANGULOV
SALES MANAGER

WE CONVEY QUALITY

WHAT CAN MOBILE EQUIPMENT DO TO REDUCE CAPEX?



WE CONVEY QUALITY

Samson® Mobile Material Feeder



MOBILE
MODULAR
MULTI FUNCTIONAL

Samson® Mobile Material Feeder

Underground Hopper

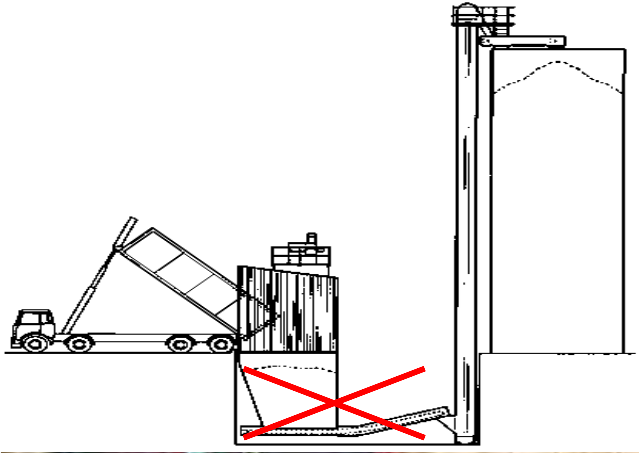

SAMSON Solution

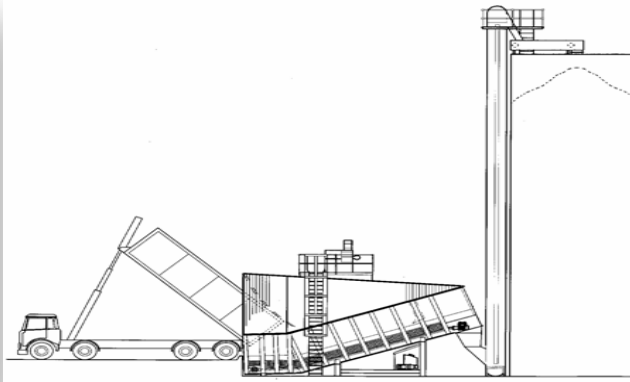

Mobile SAMSON Feeder



Suitable to receive bulk material from: -

Dump Trucks up to **+60 tons** capacity

Any type of **Standard Road Trucks** (European or US)

Any type and size of **Loading Shovel**

Samson® Mobile Material Feeder

Light to Heavy-Duty Applications

0.2t/m³

3.5t/m³

Wood Chip | Coal Gypsum | Additives
Sludge | Light Wastes Alternative Fuels Heavy Mineral Ores
Concentrates



- **Modular** Construction for Site Assembly
- Capital Expenditure **Reduced**
- **Flexible** in application and relocation
- **Multiple Materials** and **Industries Globally**
- Proven **Reliability** and **Quality**

WE CONVEY QUALITY

SAMSON Mobile Stormajor®



MOBILE
MODULAR
MULTI FUNCTIONAL

SAMSON Mobile Stormajor®

Applications: -

- Stockpiling – Open Pile
- Stockpiling – Covered Store
- Barge and Ship loading
- Rail Wagon Loading
- Intake and Transfer
- Auxiliary / Emergency Feed



SAMSON Mobile Stormajor®

*Stockpile 1.0m to 14.0m

*Slewing Range
+/- 40°

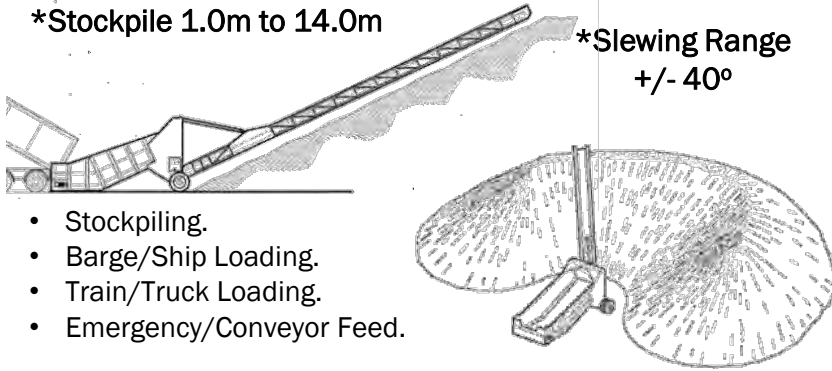

- Stockpiling.
- Barge/Ship Loading.
- Train/Truck Loading.
- Emergency/Conveyor Feed.



- Mounted on **Wheeled** or **Tracked** Chassis
- **Multiple** Applications
- **Modular** Construction for Site Assembly
- **Maximum Luffing** and **Slewing** Capability
- Proven **Reliability** and **Quality**
- **Multiple Materials** and **Industries Globally**

WE CONVEY QUALITY

SAMSON Eco-Hopper

MOBILE
MODULAR
MULTI FUNCTIONAL



SAMSON Eco-Hopper/De-Dust Hopper



Dust Control With Integrated Flex-Flap and Reverse Jet Dust Filtration System
The Flex-Flap allows free material entry but prevents fugitive dust from escaping

SAMSON Eco-Hopper/De-Dust Hopper

Key Element : - Improved Dust Reduction

Simulations to investigate the effect of different shroud heights and angles

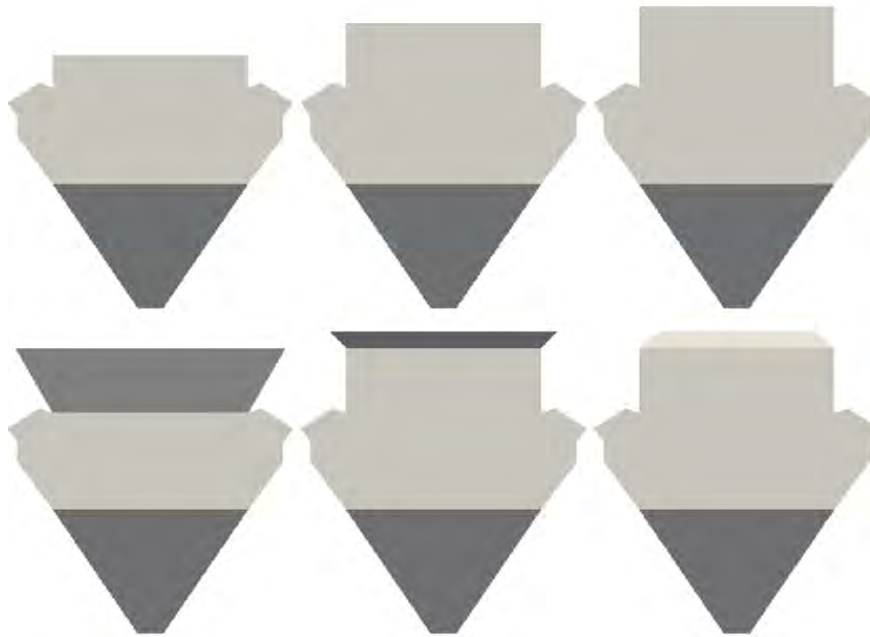

Computer modelling to understand different scenarios and propose solutions

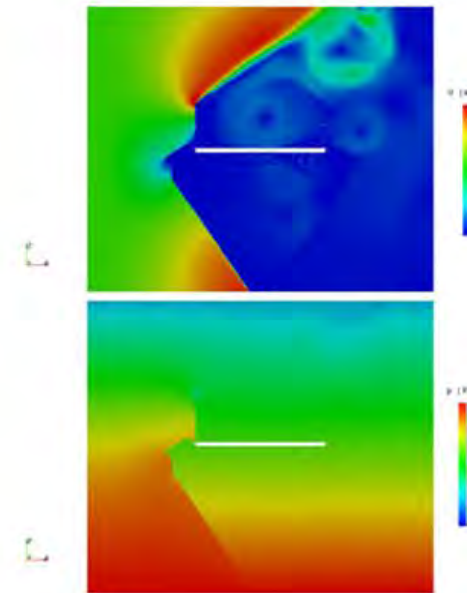
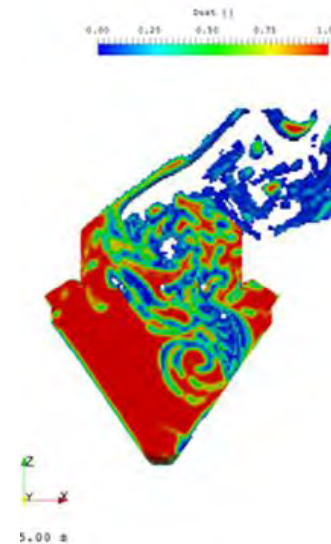

Scientific approach.

Scientific approach in design of hopper geometry and selection of dust filters provides reduced crosswind turbulence and very effective dust filtration.

SAMSON Eco-Hopper/De-Dust Hopper



WE CONVEY QUALITY

SAMSON Mobile Shiploader



MOBILE
MODULAR
MULTI FUNCTIONAL

SAMSON Mobile Shiploaders



SAMSON is the **Original Inventor** of **Mobile Cambered Boom Shiploaders** allowing for **maximum free-board clearance** but **minimal material fall** into the ships Holds, also reducing **power requirements** by upto **25%** and **reducing material degradation**

SAMSON Mobile Shiploaders



- Tailored to your Requirements
- Fully Mobile increasing Productivity
- Minimal Impact on Existing Infrastructure
- Expensive Civil Works Eliminated
- Robust Design for Marine Environment
- Proven Reliability and Quality

SAMSON Mobile Shiploaders



Shiploader with Independent **SAMSON Feeders**, **SAMSON** was the **first** to provide a solution **Direct from Truck to Ship**.

SAMSON Mobile Shiploaders



Mobile Shiploaders are easily relocated, **freeing use of the quay.** Designs available for **Wide Quays** with no or limited restrictions as well as **Narrow Quay designs with space restrictions**

SAMSON Mobile Shiploaders



Shiploader with Integral SAMSON Feeders.

Enhanced dust control by means of **Steel Enclosures** with **Full Dust Filtration** on **Feeders, Transfer, and Enclosure to Boom**, including a **Cascade type Telescopic Trimming Chute**.

SCHADE Wagon Tipplers

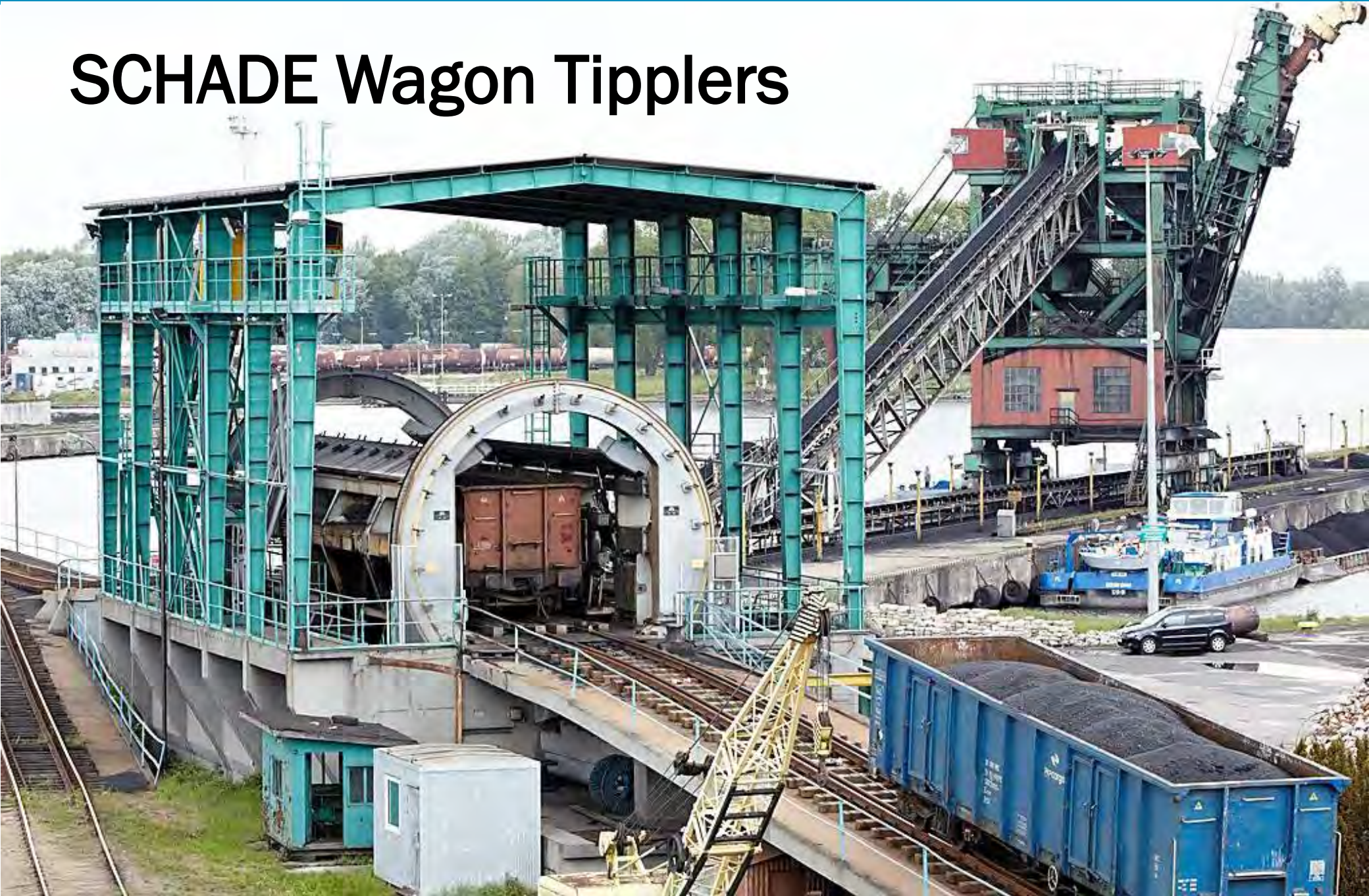

SCHADE Wagon Tipplers

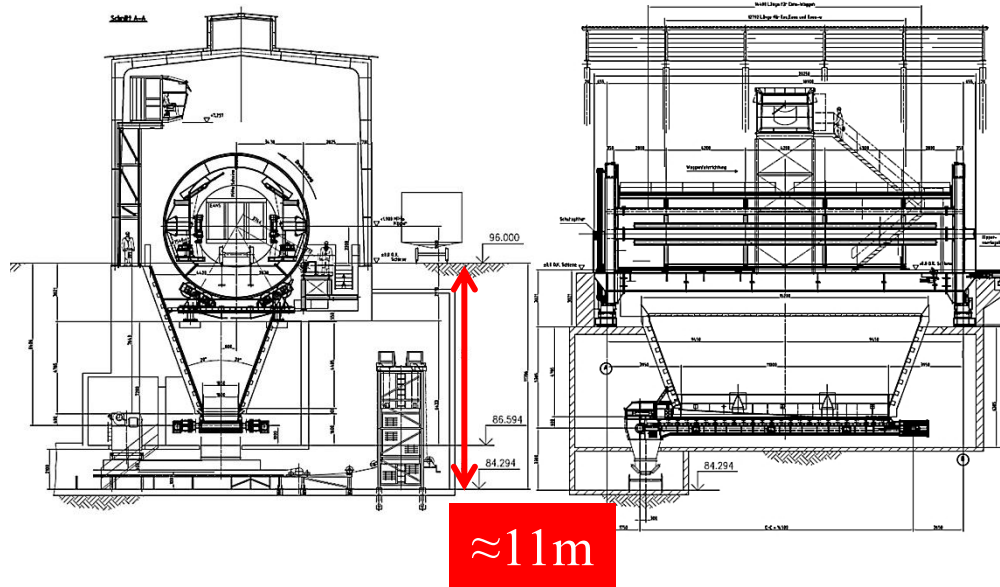

Conventional Wagon Tipplers require deep and expensive excavations which, within the Port area, may cause trouble due to high water levels. Maintaining equipment underground is both complex and expensive.

SCHADE Wagon Tipplers

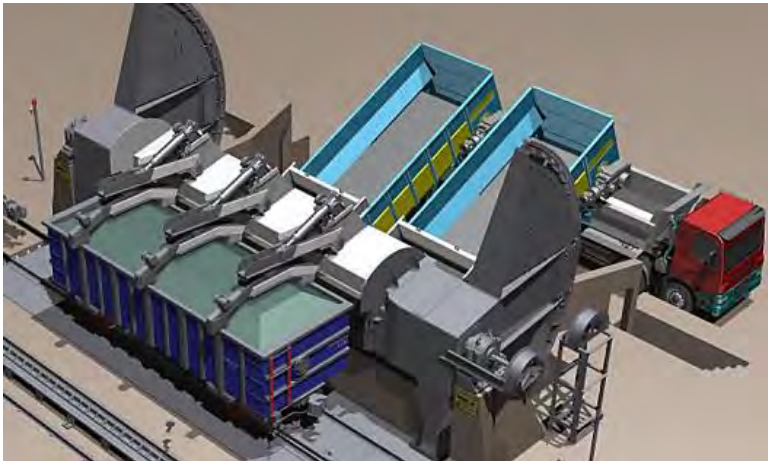
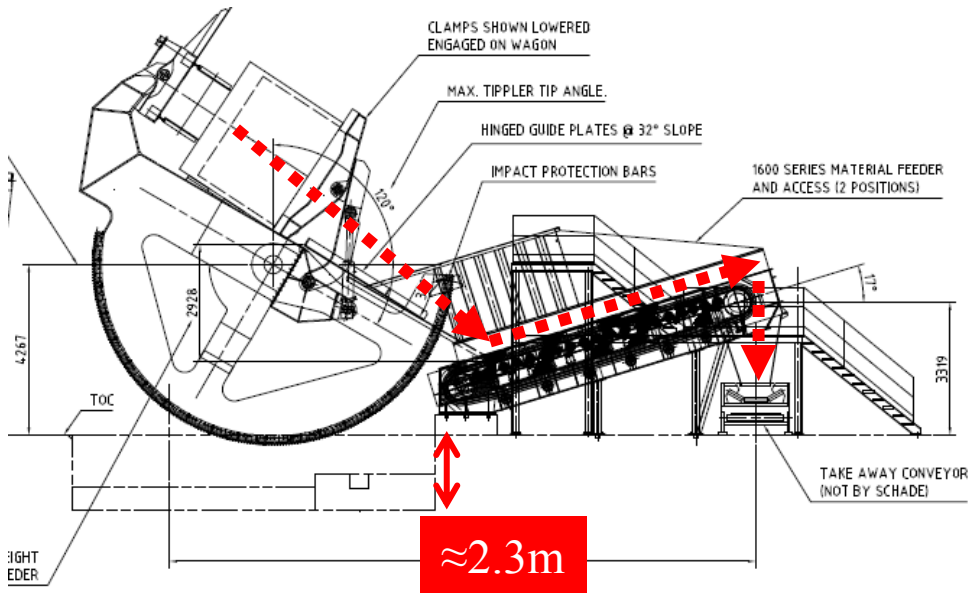

SCHADE new solution of combining Wagon Tippler with Material Feeders allows very shallow excavation.

WE CONVEY QUALITY



AUMUND Equipment

Bucket elevators

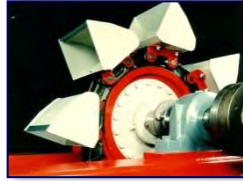

Bucket elevator

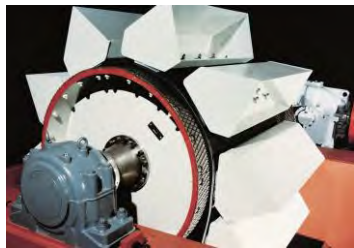
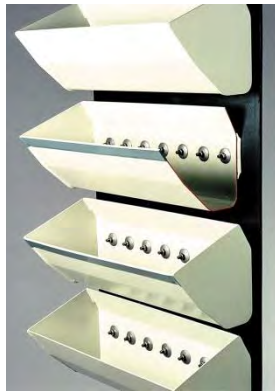

AUMUND Equipment Pan Conveyors



Bucket elevator



Pan conveyor



AUMUND Equipment

Drag chain conveyor

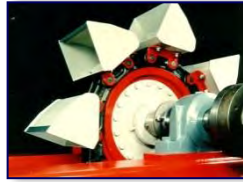

Bucket elevator



Pan conveyor



Drag chain conv.



AUMUND Equipment Armoured chain conveyor

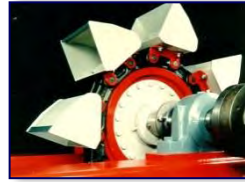
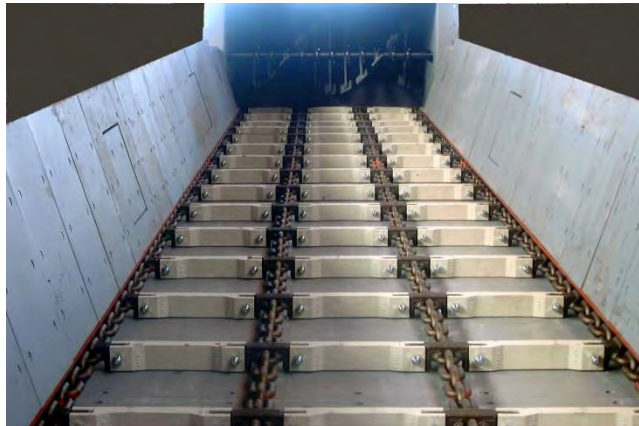

Bucket elevator



Pan conveyor



Drag chain conv.



Armoured conv.

AUMUND Equipment

Apron feeder

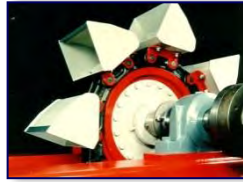

Bucket elevator



Apron feeder



Pan conveyor



Drag chain conv.



Armoured conv.

AUMUND Equipment

Apron weigh feeder

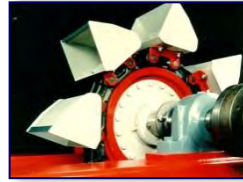
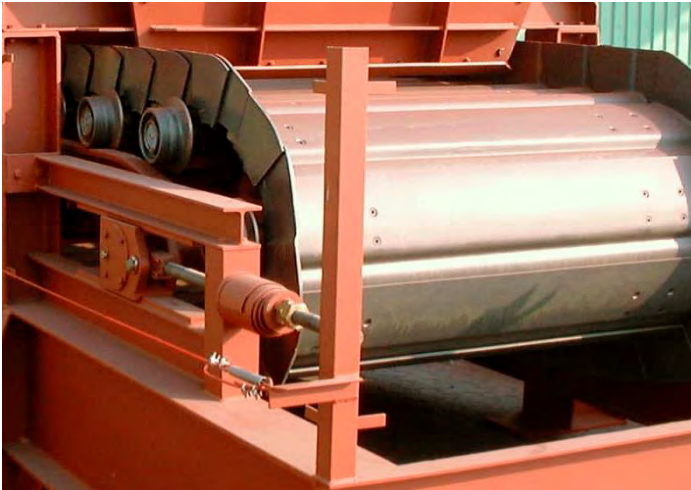

Bucket elevator



Apron feeder



Pan conveyor



Weigh feeder



Drag chain conv.



Armoured conv.

AUMUND Equipment Centrex

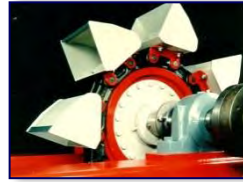
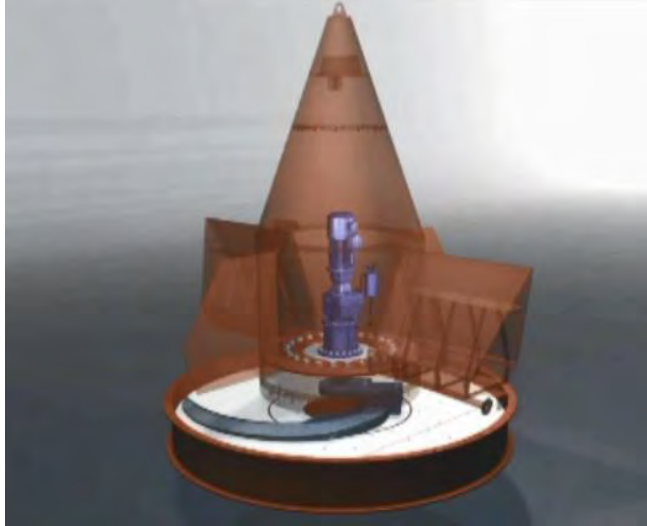

Bucket elevator



Apron feeder



Pan conveyor



Weigh feeder



Drag chain conv.



Centrex



Armoured conv.

AUMUND Equipment Rotary discharge machine

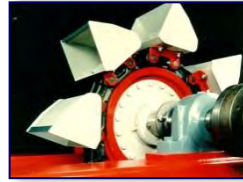
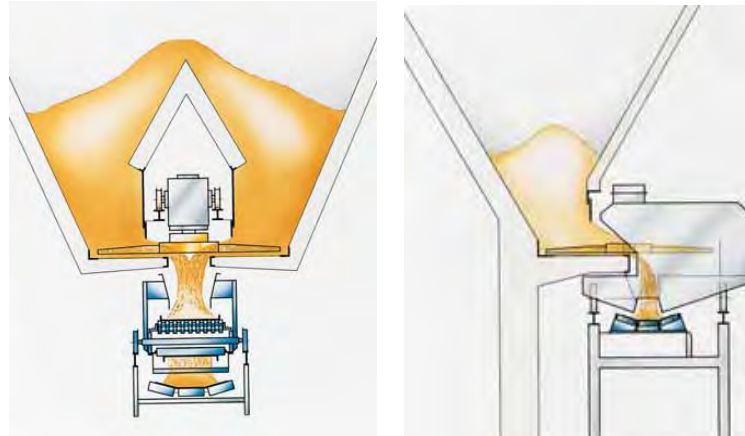

Bucket elevator



Apron feeder



Pan conveyor



Weigh feeder



Drag chain conv.



Centrex



Armoured conv.



Rotary discharger

AUMUND Equipment **SAMSON® surface feeder**

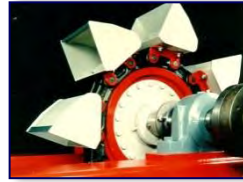

Bucket elevator



Apron feeder



Surface feeder



Pan conveyor



Weigh feeder



Drag chain conv.



Centrex



Armoured conv.



Rotary discharger

AUMUND Equipment

STORMAJOR®

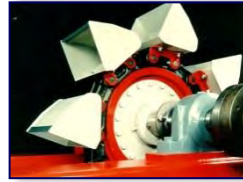

Bucket elevator



Apron feeder



Surface feeder



Pan conveyor



Weigh feeder



Boom feeder



Drag chain conv.



Centrex



Armoured conv.



Rotary discharger

AUMUND Equipment Shiploader

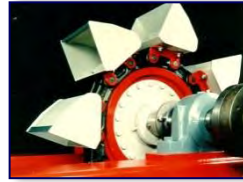

Bucket elevator



Apron feeder



Surface feeder



Pan conveyor



Weigh feeder



Boom feeder



Drag chain conv.



Centrex



Shiploader



Armoured conv.



Rotary discharger

AUMUND Equipment Eco Hopper

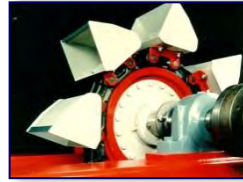
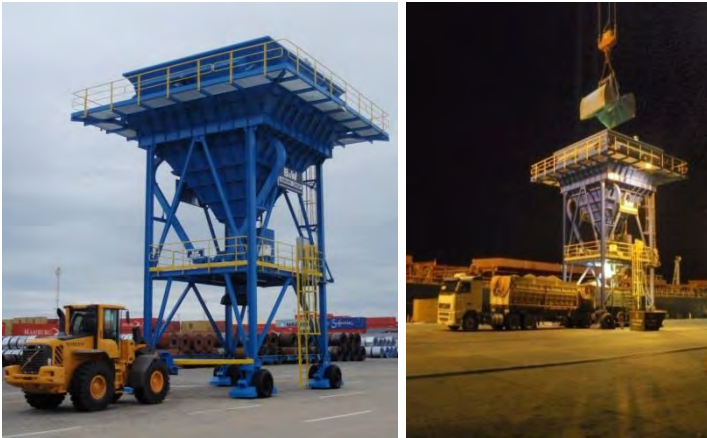

Bucket elevator



Apron feeder



Surface feeder



Pan conveyor



Weigh feeder



Boom feeder



Drag chain conv.



Centrex



Shiploader



Armoured conv.



Rotary discharger



Eco Hopper

AUMUND Equipment Stacker

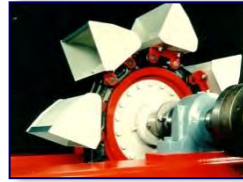

Bucket elevator



Apron feeder



Surface feeder



Stacker



Pan conveyor



Weigh feeder



Boom feeder



Drag chain conv.



Centrex



Shiploader



Armoured conv.



Rotary discharger



Eco Hopper



AUMUND Equipment Scraper Reclaimer

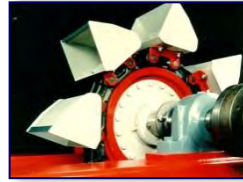

Bucket elevator



Apron feeder



Surface feeder

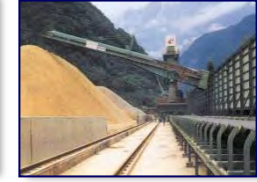

Stacker



Pan conveyor



Weigh feeder



Boom feeder



Reclaimer



Drag chain conv.



Centrex



Shiploader



Armoured conv.



Rotary discharger



Eco Hopper

AUMUND Equipment Combined Stacker reclaimer

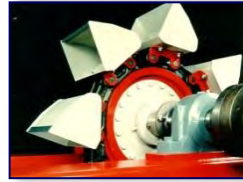

Bucket elevator



Apron feeder



Surface feeder

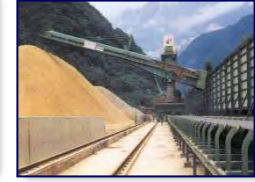

Stacker



Pan conveyor



Weigh feeder



Boom feeder



Reclaimer



Drag chain conv.



Centrex



Shiploader



Stacker Reclaimer



Armoured conv.



Rotary discharger



Eco Hopper

AUMUND Equipment Wagon tippler

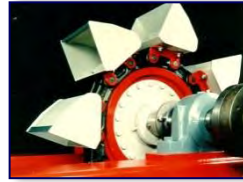
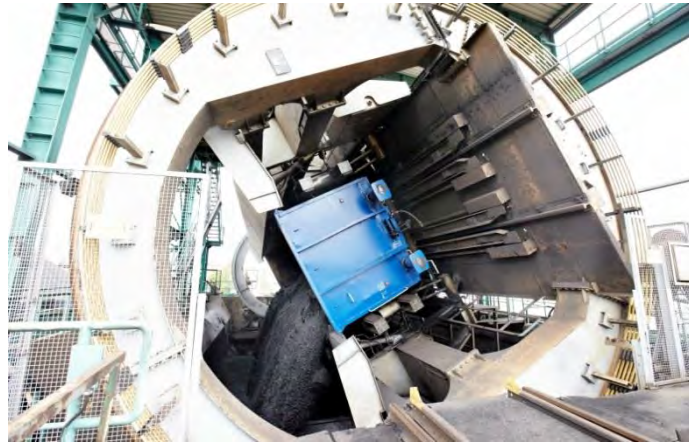

Bucket elevator



Apron feeder



Surface feeder

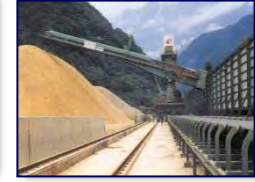

Stacker



Pan conveyor



Weigh feeder



Boom feeder



Reclaimer



Drag chain conv.



Centrex



Shiploader



Stacker Reclaimer



Armoured conv.



Rotary discharger



Eco Hopper

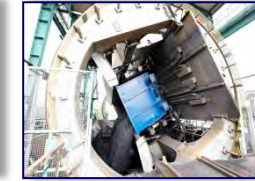

Wagon tippler

Thank you for listening

SAMSON

AUMUNDGROUP

MOBILE

MODULAR

MULTI FUNCTIONAL

Stand № 21